

## PRICE LIST 2022

JAKARTA - SURABAYA - SEMARANG - MAKASSAR - MEDAN - BALI



# Table of Contents

|                                     |    |
|-------------------------------------|----|
| Roller Blinds                       | 1  |
| Roller Blinds Component             | 2  |
| Roller Blinds Component             | 3  |
| Roller Blinds Motors                | 4  |
| Cover Box Extreme                   | 5  |
| Zebra, Venus, Ares Blinds           | 6  |
| Zebra ViewMax                       | 7  |
| Monsoon Blinds                      | 8  |
| Vertical Blinds                     | 9  |
| PVC Strip Curtain                   | 10 |
| Wooden Blinds                       | 11 |
| Venetian Blinds                     | 12 |
| Panel Shade                         | 13 |
| Honeycomb Blinds                    | 14 |
| Skylight Flat                       | 15 |
| Skylight Roman                      | 16 |
| Roman Bars                          | 17 |
| Roman Shade Tracks                  | 18 |
| Roman Shade + Fabric                | 19 |
| Hospital & Hotel Tracks             | 20 |
| Flexi Track                         | 21 |
| 82 Track                            | 22 |
| Alpha Track, Focus Track            | 23 |
| Prima Track, Econo Track            | 24 |
| 81 Track, Silent Track              | 25 |
| Super Track                         | 26 |
| Aristocrat Track, 36 Track          | 27 |
| Forta Track                         | 28 |
| Curtain Motors                      | 29 |
| Curtain Fabrics                     | 30 |
| Curtain Accessories                 | 31 |
| Awning                              | 32 |
| Kanopi Lipat                        | 33 |
| Kanopi Permanen                     | 34 |
| Tension Membrane                    | 35 |
| Tension Membrane                    | 36 |
| Shade Sail                          | 37 |
| Shade Sail                          | 38 |
| Shutter Aluminium & Wooden          | 39 |
| Pintu Expanda & Steel Security Door | 40 |
| Insect Screen                       | 41 |
| Vinyl Flooring                      | 42 |



# Our Locations



Sharp Point Thailand



Sharp Point Component Plant, China



Sharp Point Malaysia



Sharp Point Makassar



Sharp Point Medan



Sharp Point Bali



Sharp Point Surabaya

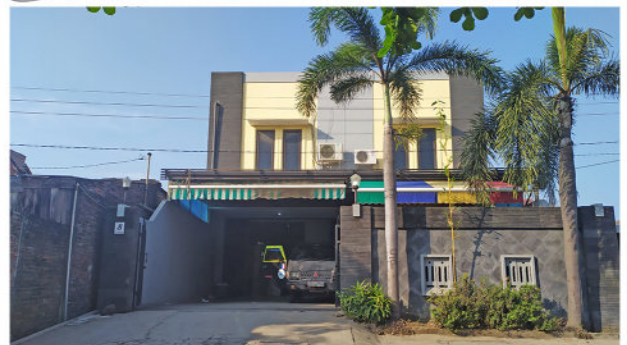

Sharp Point Semarang



Sharp Point Jakarta

**6 pabrik produksi dalam negeri merupakan jaminan keterjangkauan dalam penyelesaian proyek-proyek luar & dalam daerah**



# 2022 PRICE LIST

# Roller Blinds

5 Years Component Guarantee\*

|   | SPRING FLEXI STOP       | CHAIN 38 MM DELUXE      | CHAIN 38 XL/HD UNITY COLOR | I/O CHAIN 62 MM JUMBO +SPRING | ONE TOUCH SELF RELEASED | COVER BOX (C/B)         | C/B+ FRAME ZIPPER/ NEW WIND PROOF | FABRIC ONLY<br>min. order<br>L 1.0 x T 1.6<br>= 1.6m <sup>2</sup> |
|---|-------------------------|-------------------------|----------------------------|-------------------------------|-------------------------|-------------------------|-----------------------------------|---|
| <b>SYSTEM/BOX ONLY</b><br>minimal order L 1.60 [T rantai max 2.00]<br>■ = outdoor ready | 472.000 /m <sup>1</sup> | 350.000 /m <sup>1</sup> | 440.000 /m <sup>1</sup>    | 920.000 /m <sup>1</sup>       | 485.000 /m <sup>1</sup> | 564.000 /m <sup>1</sup> | 720.000 /mL<br>233.000 /mT        |   |
| <b>DIMOUT DELUXE SERIES</b>   |                         |                         |                            |                               |                         |                         |                                   |   |
| 202 . 707 . 9002  | 577.000                 | 470.000                 | 505.000                    | 925.000                       | 615.000                 | 665.000                 | 1.325.000                         | 289.000   |
| 303 . 505   | 628.000                 | 521.000                 | 556.000                    | 976.000                       | 666.000                 | 716.000                 | 1.376.000                         | 329.000   |
| <b>DIMOUT SUPERIOR SERIES</b>   |                         |                         |                            |                               |                         |                         |                                   |   |
| 111 . 222 . 777 . 606   | 687.000                 | 580.000                 | 615.000                    | 1.030.000                     | 725.000                 | 775.000                 | 1.435.000                         | 403.000   |
| SP Baby . ERRA . REA . ECO  | 711.000                 | 604.000                 | 639.000                    | 1.059.000                     | 749.000                 | 799.000                 | 1.459.000                         | 420.000   |
| <b>SEMI BLACK OUT &amp; BLACK OUT</b>   |                         |                         |                            |                               |                         |                         |                                   |   |
| 54 . 100B   | 664.000                 | 557.000                 | 592.000                    | 1.012.000                     | 702.000                 | 752.000                 | 1.412.000                         | 372.000   |
| <b>100% BLACK OUT</b>   |                         |                         |                            |                               |                         |                         |                                   |   |
| 6045 . 6046 . 6077 . Green Screen   | 659.000                 | 552.000                 | 587.000                    | 1.007.000                     | 697.000                 | 747.000                 | 1.407.000                         | 366.000   |
| 6044 . 6055 . 6066 . 6095 . 6028  | 744.000                 | 637.000                 | 672.000                    | 1.092.000                     | 782.000                 | 832.000                 | 1.492.000                         | 414.000   |
| 200 . 6022 . 6027 . 6029 . EQ35-6   | 852.000                 | 745.000                 | 780.000                    | 1.200.000                     | 890.000                 | 940.000                 | 1.600.000                         | 456.000   |
| <b>100% BLACK OUT PREMIUM</b>   |                         |                         |                            |                               |                         |                         |                                   |   |
| 3003 . 200Print   | 928.000                 | 821.000                 | 856.000                    | 1.276.000                     | 966.000                 | 1.016.000               | 1.676.000                         | 610.000   |
| <b>SUNSCREEN</b>  |                         |                         |                            |                               |                         |                         |                                   |   |
| 2010  | 659.000                 | 552.000                 | 587.000                    | 1.007.000                     | 697.000                 | 747.000                 | 1.407.000                         | 353.000   |
| 2600 . 4000   | 699.000                 | 592.000                 | 627.000                    | 1.047.000                     | 737.000                 | 787.000                 | 1.447.000                         | 385.000   |
| SP View . 500 . 510 . HZ . VW   | 796.000                 | 689.000                 | 724.000                    | 1.144.000                     | 834.000                 | 884.000                 | 1.544.000                         | 456.000   |
| SP 48-1% . 811  | 829.000                 | 722.000                 | 757.000                    | 1.177.000                     | 867.000                 | 917.000                 | 1.577.000                         | 507.000   |
| <b>SUNSCREEN OUTDOOR</b>  |                         |                         |                            |                               |                         |                         |                                   |   |
| PHIFER Suntext 80 . 47HT  | 882.000                 | 775.000                 | 810.000                    | 1.230.000                     | 920.000                 | 970.000                 | 1.630.000                         | 519.000   |
| PHIFER Suntext 90 . DX61  | 1.012.000               | 905.000                 | 940.000                    | 1.360.000                     | 1.050.000               | 1.100.000               | 1.760.000                         | 546.000   |
| <b>SUNSCREEN FIBERGLASS</b>   |                         |                         |                            |                               |                         |                         |                                   |   |
| 8066 Alumunium Coating  | 1.232.000               | 1.125.000               | 1.160.000                  | 1.580.000                     | 1.270.000               | 1.320.000               | 1.980.000                         | 960.000   |
| <b>ART PATTERN</b>  |                         |                         |                            |                               |                         |                         |                                   |   |
| PP . PJ . PR  | 835.000                 | 728.000                 | 763.000                    | 1.183.000                     | 873.000                 | 923.000                 | 1.583.000                         | 466.000   |
| Glass Film 60 - 80%   | 962.000                 | 855.000                 | 890.000                    | 1.310.000                     | 1.000.000               | 1.050.000               | 1.710.000                         | 562.000   |
| <b>ART PATTERN PREMIUM</b>  |                         |                         |                            |                               |                         |                         |                                   |   |
| APJ Series . APP Series   | 1.027.000               | 920.000                 | 955.000                    | 1.375.000                     | 1.065.000               | 1.115.000               | 1.775.000                         | 662.000   |
| <b>fabrics by Serge Ferrari</b>   |                         |                         |                            |                               |                         |                         |                                   |   |
| S99 <Indoor>   S86 . S92 . S96 <Outdoor>  | 1.305.000               | 1.198.000               | 1.233.000                  | 1.653.000                     | 1.343.000               | 1.393.000               | 2.053.000                         | 900.000   |
| S88 Alu LowE . S99 Alu LowE   | 1.439.000               | 1.332.000               | 1.367.000                  | 1.787.000                     | 1.477.000               | 1.527.000               | 2.187.000                         | 920.000   |
| W96 . FFSK20 Fire Shade   | 1.612.000               | 1.505.000               | 1.540.000                  | 1.960.000                     | 1.650.000               | 1.700.000               | 2.360.000                         | 1.200.000   |
| B92   | 1.947.000               | 1.840.000               | 1.875.000                  | 2.295.000                     | 1.985.000               | 2.035.000               | 2.695.000                         | 1.525.000   |
| <b>OUTDOOR</b>  |                         |                         |                            |                               |                         |                         |                                   |   |
| Dickson Orchestra by Glenraven  | 1.238.000               | 1.131.000               | 1.166.000                  | 1.586.000                     | 1.276.000               | 1.326.000               | 1.986.000                         | 850.000   |
| Mehler Valmax   | 1.220.000               | 1.113.000               | 1.148.000                  | 1.568.000                     | 1.258.000               | 1.308.000               | 1.968.000                         | 845.000   |
| Arashi  | 1.026.000               | 919.000                 | 954.000                    | 1.374.000                     | 1.064.000               | 1.114.000               | 1.774.000                         | 660.000   |
| Projector Screen  | 899.000                 | 792.000                 | 827.000                    | 1.247.000                     | 937.000                 | 987.000                 | 1.647.000                         | 550.000   |

## HARGA SUDAH TERMASUK PPN

1. Pemesanan set komplet minimum charge lebar 100 cm & tinggi 100 cm = 1.00m<sup>2</sup> (lebar dan tinggi kurang dari 1m dihitung 1m)
2. Biaya pemasangan daerah Jakarta = Rp. 11.000/m<sup>2</sup> (minimal 15m<sup>2</sup>)



UV DIGITAL PRINTING  
/ CETAK SABLON

Rp. 245.000/m<sup>2</sup> (netto)  
(penghitungan mengikuti volume media fabric, minimal 1m<sup>2</sup>)



DIGITAL PRINTING  
DOUBLE BLOCK (FLAT BED)

Rp. 350.000/m<sup>2</sup> (netto)  
(penghitungan mengikuti volume media fabric, minimal 1m<sup>2</sup>)



38 MM  
BRACKET

Rp. 9.300/pcs



SILENT  
BOTTOM

Rp. 137.000/m<sup>1</sup>

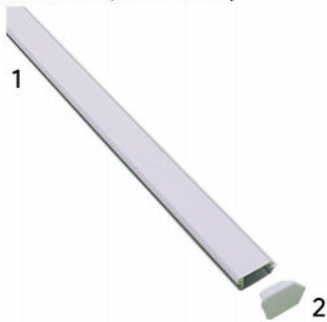

1. BOTTOM RAIL STANDARD

Rp. 95.000/m<sup>1</sup>

2. BOTTOM RAIL CUP STANDAR

Rp. 4.300/pcs



STICKY BRACKET

Rp. 93.000/pcs



JOINT SYSTEM

Rp. 275.000/pcs



DOUBLE BRACKET 38-38

Rp. 281.000/pcs



90° JOINT

Tube 50mm : Rp. 1.437.000/pcs  
Tube 65mm : Rp. 1.500.000/pcs  
Tube 90mm : Rp. 1.812.000/pcs



180° INTERMEDIATE 50 - 65

Tube 50mm : Rp. 506.000/pcs  
Tube 65mm : Rp. 812.000/pcs  
Tube 90mm : Rp. 1.187.000/pcs

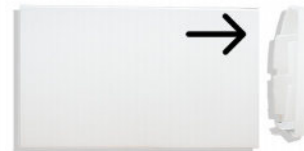

HEAVY BOTTOM + END CUP

A. Rp. 200.000/m<sup>1</sup>  
B. Rp. 8.100/pcs



OPERATION CHAIN

6 mm : Rp. 7.500 /m<sup>1</sup>  
7.2 mm : Rp. 18.000 /m<sup>1</sup>  
7.2 mm clear : Rp. 23.000 /m<sup>1</sup>  
6 mm s/s : Rp. 57.000 /m<sup>1</sup>

## Upgrade

|                    |                                |
|--------------------|--------------------------------|
| Tube 50 mm         | : Rp. 412.000/m <sup>1</sup>   |
| Tube 62 mm         | : Rp. 537.000/m <sup>1</sup>   |
| Tube 65 mm + Crown | : Rp. 562.000/m <sup>1</sup>   |
| Tube 78 mm + Crown | : Rp. 870.000/m <sup>1</sup>   |
| Tube 90 mm + Crown | : Rp. 1.008.000/m <sup>1</sup> |

|  |                              |
|--|------------------------------|
| Control Unit Chain HD / XL + Spring                                      | : Rp. 375.000/set            |
| Tube Tebal (38mm x 2.0 mm)   | : Rp. 257.000/m <sup>1</sup> |
| Side guide aluminium + inside part                                       | : Rp. 262.000/m <sup>1</sup> |
| 50mm extreme size mechanism + spring<br>(penambahan harga dari Chain XL) | : Rp. 1.247.000/set          |

## HARGA SUDAH TERMASUK PPN

|  |                                     |
|--|-------------------------------------|
| 1. Biaya pasang (wilayah Jakarta. min 15m <sup>2</sup> )                     | : Rp. 11.000/m <sup>2</sup> (netto) |
| 2. Biaya pasang outdoor (wilayah Jakarta. min 15m <sup>2</sup> )             | : Rp. 25.000/m <sup>2</sup> (netto) |
| 3. Biaya service potong lebar / tinggi (tidak termasuk biaya ganti komponen) | : Rp. 66.000/set (netto)            |



**A. Wire Lock Span**  
 6 mm = Rp. 200.000/pcs  
 8 mm = Rp. 219.000/pcs  
 12 mm = Rp. 475.000/pcs

**B. Siku L Stainless Steel**  
 Rp. 106.000/pcs

**WIRE LOCK SPAN / ANGKUR**  
**Stainless Steel Wire**

|        |                            |
|--------|----------------------------|
| 1.5 mm | Rp. 35.000/m <sup>1</sup>  |
| 2.0 mm | Rp. 50.000/m <sup>1</sup>  |
| 2.5 mm | Rp. 65.000/m <sup>1</sup>  |
| 3.0 mm | Rp. 83.000/m <sup>1</sup>  |
| 4.0 mm | Rp. 132.000/m <sup>1</sup> |
| 6.0 mm | Rp. 177.000/m <sup>1</sup> |
| 8.0 mm | Rp. 312.000/m <sup>1</sup> |



**HAND CRANK + CONTROL**  
**A. Control Unit** Rp. 863.000/pcs  
 (include bracket & Idler)

**B. Hand Crank**

|       |                 |
|-------|-----------------|
| 1.5 m | Rp. 312.000/pcs |
| 2.0 m | Rp. 375.000/pcs |
| 2.5 m | Rp. 437.000/pcs |
| 3.0 m | Rp. 500.000/pcs |



**WIRE LOCK MOUNT SET**

|                                 |                   |
|---------------------------------|-------------------|
| <b>A. Bracket</b>               | Rp. 225.000/pcs   |
| <b>B. Stainless Wire Adjust</b> | Rp. 356.000/pcs   |
| <b>C. Wire Lock Mount</b>       | Rp. 1.000.000/pcs |
| <b>D. Bracket Idler</b>         | Rp. 100.000/pcs   |
| <b>E. Idler tube 65mm</b>       | Rp. 162.000/pcs   |

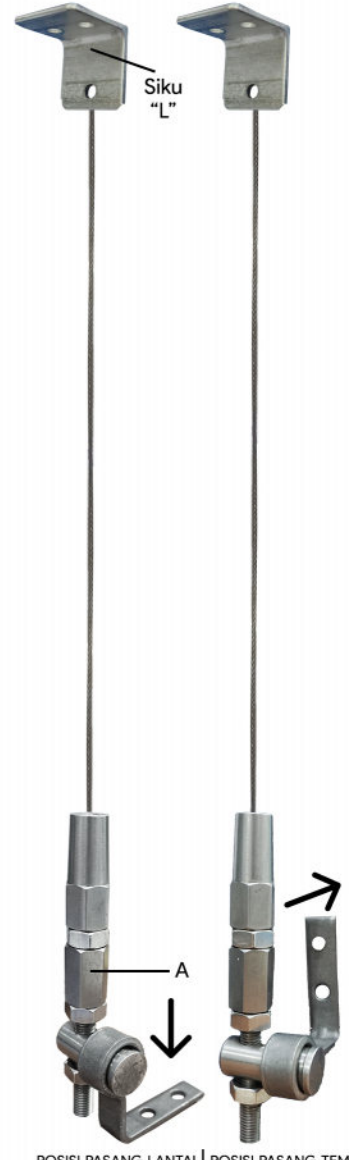

**STRENGTH ADJUST PART SET**  
**A. Strength Adjust Part**  
 Rp. 813.000/pcs

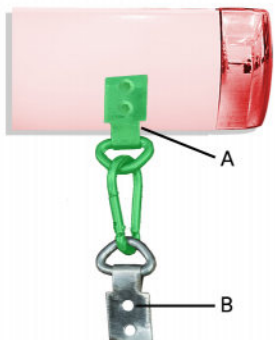

**CARABINER HOOK**

|                          |                |
|--------------------------|----------------|
| <b>A. Carabiner Hook</b> | Rp. 61.000/pcs |
| <b>B. Ring D</b>         | Rp. 56.000/pcs |

**A. Heavy Bottom + End Cup Nylon**

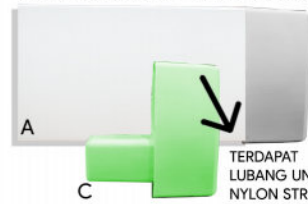

**B. Heavy Bottom + End Cup S/S**



**HEAVY BOTTOM**

|                         |                           |
|-------------------------|---------------------------|
| <b>C. End Cup Nylon</b> | Rp. 21.000/pcs            |
| <b>D. S/S End Cup</b>   | Rp. 337.000/pcs           |
| <b>Nylon String</b>     |                           |
| 1.5-2.0 mm              | Rp. 30.000/m <sup>1</sup> |
| 2.5 mm                  | Rp. 36.000/m <sup>1</sup> |
| 3 mm                    | Rp. 62.000/m <sup>1</sup> |
| 4 mm                    | Rp. 85.000/m <sup>1</sup> |

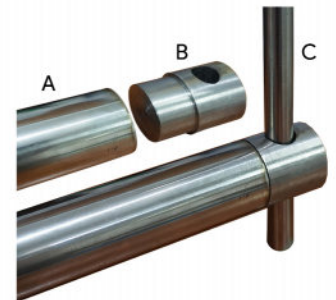





**STAINLESS BOTTOM + GUIDE**

|                                    |                            |
|------------------------------------|----------------------------|
| <b>A. Pipe</b>                     |                            |
| 0.75"                              | Rp. 206.000/m <sup>1</sup> |
| 1.0"                               | Rp. 277.000/m <sup>1</sup> |
| 1.25"                              | Rp. 337.000/m <sup>1</sup> |
| 1.5"                               | Rp. 425.000/m <sup>1</sup> |
| 2.0"                               | Rp. 567.000/m <sup>1</sup> |
| <b>B. End Cup 1.25"(ss)</b>        | Rp. 375.000/pcs            |
| <b>C. Side Guide Pipe 0.5"(ss)</b> | Rp. 150.000/m <sup>1</sup> |

### RTS Motor

1 Set = Motor, Crown, Wheel, Idler, Kabel Power 2m, Steker

|  |                            |                     |
|--|----------------------------|---------------------|
|    | SOMFY Altus 40 RTS 4/14    | Rp. 4.750.000 /set  |
|    | SOMFY Altus 40 RTS 4/16    | Rp. 6.500.000 /set  |
|    | SOMFY Altus 50 RTS 6/32    | Rp. 9.100.000 /set  |
|    | SOMFY Altus 50 RTS 10/32   | Rp. 9.360.000 /set  |
|    | SOMFY Altus 50 RTS 40/17   | Rp. 12.200.000 /set |
|    | SOMFY Altus 60 RTS 85/17   | Rp. 19.200.000 /set |
|    | SOMFY Altus 60 RTS 100/12  | Rp. 22.500.000 /set |
|    | SOMFY Altus 60 RTS 120/12  | Rp. 24.200.000 /set |
|    | SOMFY Sonesse 40 RTS 3/30  | Rp. 11.800.000 /set |
|    | SOMFY Sonesse 40 RTS 6/20  | Rp. 12.600.000 /set |
|    | SOMFY Sonesse 50 RTS 6/28  | Rp. 13.500.000 /set |
|    | SOMFY Sonesse 50 RTS 10/28 | Rp. 14.150.000 /set |
|    | SOMFY Sonesse 50 RTS 15/17 | Rp. 15.300.000 /set |
|    | SOMFY LSN 40 RTS 6/28      | Rp. 6.850.000 /set  |
|   | SOMFY LSN 40 RTS 9/16      | Rp. 8.100.000 /set  |
|  | SHARP POINT RTS 10/28      | Rp. 3.500.000 /set  |
|  | SHARP POINT RTS 40/12      | Rp. 4.250.000 /set  |
|  | SHARP POINT 59 WT 100/12   | Rp. 6.700.000 /set  |
|  | NOVO K-45-EL 15/28         | Rp. 3.000.000 /set  |
|  | NOVO K-45-EL 50/12         | Rp. 3.500.000 /set  |
|  | DOOYA DM-45-M 50/12        | Rp. 3.800.000 /set  |
|  | CHERUBINI Roll 40/17       | Rp. 5.100.000 /set  |
|  | CHERUBINI Senso RX 7/30    | Rp. 9.500.000 /set  |
|  | CHERUBINI Senso RX 15/30   | Rp. 9.650.000 /set  |
|  | CHERUBINI Wave RX 85/17    | Rp. 13.850.000 /set |

### Wired Motor

1 Set = Motor, Crown, Wheel, Idler, Kabel Power 2m, Steker (tanpa receiver)

|  |                        |                     |
|--|------------------------|---------------------|
|  | SOMFY Solus 2 PA 40/12 | Rp. 5.850.000 /set  |
|  | SOMFY Ariane 6/32      | Rp. 7.350.000 /set  |
|  | SOMFY Taurus 120/12    | Rp. 21.900.000 /set |

### Controllers

|                                |                     |
|--------------------------------|---------------------|
| SOMFY Receiver Universal Inteo | Rp. 6.200.000 /unit |
| SOMFY Remote Situo RTS 1 Ch    | Rp. 985.000 /unit   |
| SOMFY Remote Situo 1 Ch Pure   | Rp. 1.345.000 /unit |
| SOMFY Remote Situo 2 Ch Pure   | Rp. 1.995.000 /unit |
| SOMFY Remote Situo 5 Ch Pure   | Rp. 2.400.000 /unit |
| SOMFY Telis 16 RTS Pure Intl   | Rp. 8.300.000 /unit |
| Dry Contact Transmitter        | Rp. 8.350.000 /unit |
| Connexoon RTS                  | Rp. 6.500.000 /unit |
| Control Switch WT Inis Single  | Rp. 705.000 /unit   |
| Control Switch WT Inis Double  | Rp. 880.000 /unit   |
| Smoove Origin RTS              | Rp. 1.580.000 /unit |
| Telis Silver 1 Ch              | Rp. 1.850.000 /unit |
| Telis Silver 4 Ch              | Rp. 2.950.000 /unit |
| Cherubini Remote 1 Ch          | Rp. 1.900.000 /unit |
| Cherubini Remote 5 Ch          | Rp. 2.100.000 /unit |
| Sharp Point Receiver           | Rp. 1.400.000 /unit |
| Sharp Point Remote 1-5 Ch      | Rp. 720.000 /unit   |
| Novo Receiver                  | Rp. 660.000 /unit   |
| Novo Remote 1-5 Ch             | Rp. 660.000 /unit   |
| Dooya Receiver                 | Rp. 660.000 /unit   |
| Dooya Remote                   | Rp. 490.000 /unit   |

### System Components

|  |                               |
|--|-------------------------------|
| 50 mm Tube + HD Bottom Rail + End Cup PVC    | Rp. 508.000 /m <sup>1</sup>   |
| 65/62 mm Tube + HD Bottom Rail + End Cup PVC | Rp. 609.000 /m <sup>1</sup>   |
| 90 mm Tube + HD Bottom Rail + End Cup PVC    | Rp. 1.079.000 /m <sup>1</sup> |
| 160 mm Tube + HD Bottom Rail + End Cup PVC   | Rp. 5.080.000 /m <sup>1</sup> |
| Bracket Somfy / NOVO                         | Rp. 266.000 /pcs              |
| Bracket Idler                                | Rp. 101.000 /pcs              |
| Bracket Lengthen Somfy / NOVO                | Rp. 311.000 /pcs              |
| Bracket Idler Lengthen Somfy / NOVO          | Rp. 146.000 /pcs              |
| 50 mm Tube                                   | Rp. 412.000 /m <sup>1</sup>   |
| 62 mm Tube                                   | Rp. 537.000 /m <sup>1</sup>   |
| 65 mm Tube + Crown                           | Rp. 562.000 /m <sup>1</sup>   |
| 78 mm Tube + Crown                           | Rp. 870.000 /m <sup>1</sup>   |
| 90 mm Tube+ Crown                            | Rp. 1.008.000 /m <sup>1</sup> |
| Bracket Tube 160 mm                          | Rp. 2.413.000 /set            |
| 160 mm Tube                                  | Rp. 4.699.000 /m <sup>1</sup> |
| Bottom Rail Heavy Duty                       | Rp. 200.000 /m <sup>1</sup>   |
| Bottom Rail Silent                           | Rp. 266.000 /m <sup>1</sup>   |
| Bottom Rail Pulling                          | Rp. 292.000 /m <sup>1</sup>   |

### HARGA SUDAH TERMASUK PPN

1. Pemesanan set komplit minimum charge lebar 100 cm & tinggi 100 cm = 1.00m<sup>2</sup>
2. Biaya pemasangan daerah Jakarta : Rp. 250.000/set (netto)
3. Biaya pemasangan Bodetabek : Rp. 450.000/set (netto)
4. Biaya pemasangan belum termasuk steger, konstruksi, sipil dan instalasi listrik tambahan

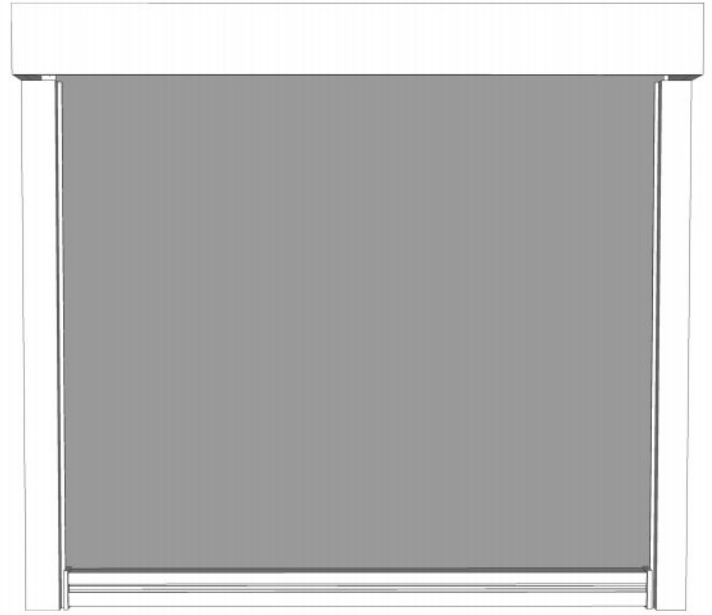
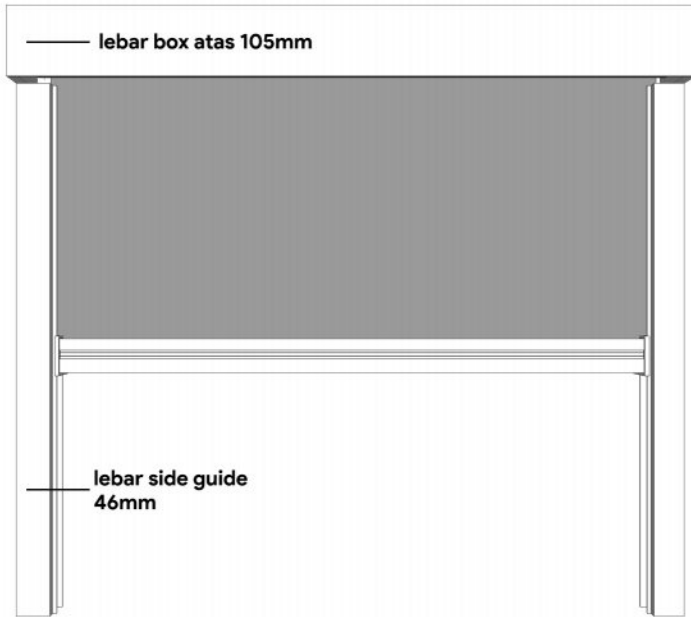

Cover box With Frame

Rp. 1.708.000/m<sup>2</sup>

#### HARGA SUDAH TERMASUK PPN

1. Minimal order cover box extreme = 4m<sup>2</sup>  
lebar & tinggi kurang dari 2.00 m tetap dihitung 2.00 m
2. Ukuran maksimal L 8.00 m dan T 8.00m
3. Harga sudah termasuk tube 78 mm
4. Harga fabric : lihat halaman 1 (kolom *fabric only*)
5. Harga motorized : lihat halaman 4
6. Biaya pemasangan daerah Jakarta = Rp 250.000/set (netto)



|                             | WITH COVER BOX            | COVER BOX UNITY COLOR     | FABRIC ONLY DOUBLE SIDE<br>min order<br>L 1.0 x T 1.6 = 1.6m <sup>2</sup> |
|-----------------------------|---------------------------|---------------------------|---|
| <b>ZEBRA BLINDS</b>         |                           |                           |   |
| *System Only                | 680.000 /m'               | 780.000 /m'               | -   |
| Z-88 Polyester Dim Out      | 870.000 /m <sup>2</sup>   | 1.060.000 /m <sup>2</sup> | 450.000 /m <sup>2</sup>   |
| Z-77 Polyester Dim Out      | 1.030.000 /m <sup>2</sup> | 1.220.000 /m <sup>2</sup> | 562.000 /m <sup>2</sup>   |
| Z-33 & JXX Super Sun Screen | 1.680.000 /m <sup>2</sup> | 1.878.000 /m <sup>2</sup> | 882.000 /m <sup>2</sup>   |
| Z-BO-R Polyester Black Out  | 1.415.000 /m <sup>2</sup> | 1.610.000 /m <sup>2</sup> | 930.000 /m <sup>2</sup>   |
| Z-BO-M Polyester Black Out  | 1.324.000 /m <sup>2</sup> | 1.520.000 /m <sup>2</sup> | 840.000 /m <sup>2</sup>   |

\*system only minimal order L 1.60m (tinggi rantai maksimal 2.00m)



|                               | WITH COVER BOX            | COVER BOX UNITY COLOR     | FABRIC ONLY DOUBLE SIDE<br>min order<br>L 1.0 x T 1.6 = 1.6m <sup>2</sup> |
|-------------------------------|---------------------------|---------------------------|---|
| <b>VENUS BLINDS</b>           |                           |                           |   |
| *System Only                  | 800.000 /m'               | 925.000 /m'               | -   |
| VSG                           | 1.396.000 /m <sup>2</sup> | 1.672.000 /m <sup>2</sup> | 922.000 /m <sup>2</sup>   |
| VSG Black Out, Dolce Metallic | 2.200.000 /m <sup>2</sup> | 2.470.000 /m <sup>2</sup> | 1.300.000 /m <sup>2</sup>   |
| VSG Seri 6                    | 1.200.000 /m <sup>2</sup> | 1.380.000 /m <sup>2</sup> | 783.000 /m <sup>2</sup>   |
| VSG Seri 9                    | 1.750.000 /m <sup>2</sup> | 1.986.000 /m <sup>2</sup> | 1.140.000 /m <sup>2</sup>   |
| VSG Seri 10                   | 1.820.000 /m <sup>2</sup> | 2.050.000 /m <sup>2</sup> | 1.200.000 /m <sup>2</sup>   |

\*system only minimal order L 1.60m (tinggi rantai maksimal 2.00m)



|                    | WITH COVER BOX            | COVER BOX UNITY COLOR     | FABRIC ONLY DOUBLE SIDE<br>min order<br>L 1.0 x T 1.6 = 1.6m <sup>2</sup> |
|--------------------|---------------------------|---------------------------|---|
| <b>ARES BLINDS</b> |                           |                           |   |
| System Only        | 805.000 /m'               | 927.000 /m'               | -   |
| RA                 | 1.210.000 /m <sup>2</sup> | 1.537.000 /m <sup>2</sup> | 804.000 /m <sup>2</sup>   |
| EQ35-6 Tawn        | 830.000 /m <sup>2</sup>   | 1.070.000 /m <sup>2</sup> | 600.000 /m <sup>2</sup>   |

\*system only minimal order L 1.60m (tinggi rantai maksimal 2.00m)



Posisi Tertutup

Posisi Terbuka

### HARGA SUDAH TERMASUK PPN

1. Minimum order Lebar dan Tinggi kurang dari 1m dibulatkan menjadi 1m (lebar dan tinggi kurang dari 1m dihitung 1m)
2. Biaya pemasangan daerah Jakarta = Rp. 11.000/m<sup>2</sup> netto (minimal 15m<sup>2</sup>)

### WITH COVER BOX

### COVER BOX UNITY COLOR

### FABRIC ONLY DOUBLE SIDE

min order  
L 1.0 x T 1.6 = 1.6m<sup>2</sup>

### ZEBRA VIEWMAX

System Only

Z-88 Polyester Dim Out

Z-77 Polyester Dim Out

Z-33 & JXX Super Sun Screen

Z-BO-R Polyester Black Out

Z-BO-M Polyester Black Out

875.000 /m'

1.194.000 /m<sup>2</sup>

1.460.000 /m<sup>2</sup>

2.063.000 /m<sup>2</sup>

1.900.000 /m<sup>2</sup>

1.813.000 /m<sup>2</sup>

975.000 /m'

1.369.000 /m<sup>2</sup>

1.619.000 /m<sup>2</sup>

2.238.000 /m<sup>2</sup>

2.075.000 /m<sup>2</sup>

1.988.000 /m<sup>2</sup>

-

475.000 /m<sup>2</sup>

585.000 /m<sup>2</sup>

918.000 /m<sup>2</sup>

975.000 /m<sup>2</sup>

875.000 /m<sup>2</sup>

\*system only minimal order L 1.60m (tinggi rantai maksimal 2.00m)

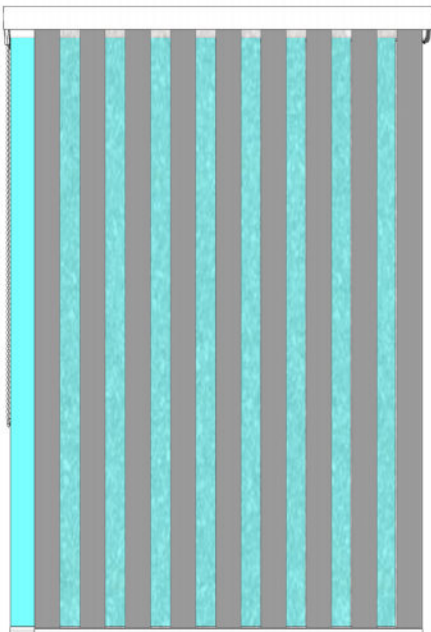

Posisi Tertutup

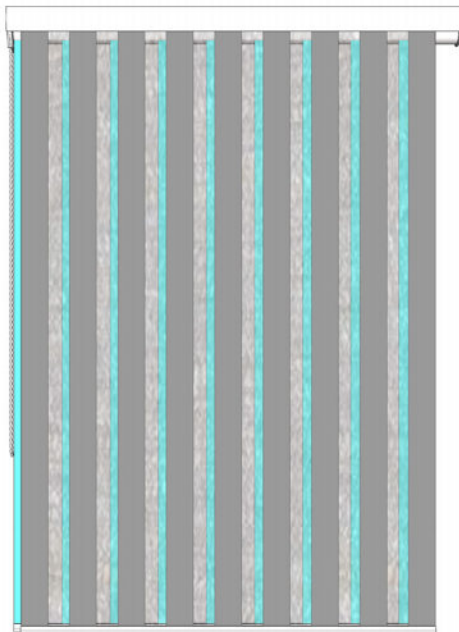

Posisi 1/2 Terbuka

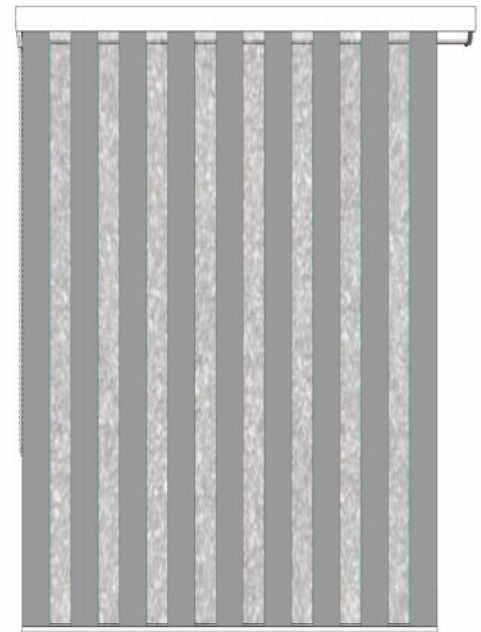

Posisi Terbuka

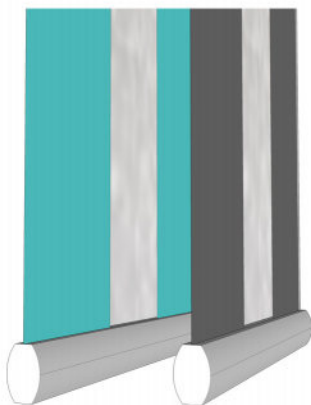

Tampak Samping  
(2 Layer)

### HARGA SUDAH TERMASUK PPN

1. Minimum order Lebar dan Tinggi kurang dari 1m dibulatkan menjadi 1m (lebar dan tinggi kurang dari 1m dihitung 1m)
2. Biaya pemasangan daerah Jakarta = Rp. 11.000/m<sup>2</sup> netto (minimal 15m<sup>2</sup>)

|       |               |          | Tinggi          |             |             |             |             |
|-------|---------------|----------|-----------------|-------------|-------------|-------------|-------------|
|       |               |          | 3 BR            | 4 BR        | 5 BR        | 6 BR        | 7 BR        |
|       |               |          | tinggi s/d 2.00 | 2.01 - 2.80 | 2.81 - 3.60 | 3.61 - 4.40 | 4.41 - 5.20 |
| Lebar | s/d 1.50      | 2P / 2LW | 8.223.000       | 9.260.000   | 10.346.000  | 11.444.000  | 12.518.000  |
|       | 1.51 s/d 2.50 | 3P / 2LW | 11.688.000      | 12.713.000  | 13.799.000  | 14.884.000  | 15.982.000  |
|       | 2.51 s/d 3.50 | 3P / 2LW | 14.067.000      | 15.165.000  | 16.251.000  | 17.337.000  | 18.410.000  |
|       | 3.51 s/d 4.50 | 4P / 3LW | 18.081.000      | 18.923.000  | 20.008.000  | 21.094.000  | 22.180.000  |
|       | 4.51 s/d 5.50 | 4P / 3LW | 20.143.000      | 21.228.000  | 22.314.000  | 23.412.000  | 24.510.000  |

### HARGA SUDAH TERMASUK

1. P : Pully
2. LW : Line Wire Stainless
3. BR : Backing Bar
4. Ring U / W / D (Stainless)
5. Bahan PVC Clear Korea
6. Lis bahan Dickson (Acrylic Fabric, Anti UV)
7. Siku "L" 5 x 5cm
8. Magic Tape / Velcro

### HARGA BELUM TERMASUK

1. Manual Chain System + Control Mechanism set HD
2. Strength Adjust Part
3. Motorized System
4. Komponen Outdoor

\*HARGA DI HALAMAN 2



### Monsoon Blinds Roller Type

(with Chain XL + Spring + 0.6mm Clear PVC Fabric)

Rp. 842.000 /m<sup>2</sup>  
(Max ukuran L 1.20m x T 2.50m)

### Monsoon Blinds Roller Type + Spring

(with Chain Oversize 50mm Tube + 0.6mm Clear PVC Fabric)

Rp 1.001.000 /m<sup>2</sup>  
(Max ukuran L 2.00m x T 3.00m sambung press)



|                     |       |                           |
|---------------------|-------|---------------------------|
| Tube 50 mm          | : Rp. | 412.000 /m <sup>1</sup>   |
| Tube 62 mm          | : Rp. | 537.000 /m <sup>1</sup>   |
| Tube 65 mm + Crown  | : Rp. | 562.000 /m <sup>1</sup>   |
| Tube 78 mm + Crown  | : Rp. | 870.000 /m <sup>1</sup>   |
| Tube 90 mm + Crown  | : Rp. | 1.008.000 /m <sup>1</sup> |
| 90° Joint Tube 50mm | : Rp. | 1.437.000 /pcs            |
| 90° Joint Tube 65mm | : Rp. | 1.500.000 /pcs            |
| 90° Joint Tube 90mm | : Rp. | 1.812.000 /pcs            |

|  |                 |
|--|-----------------|
| Hand Crank Control Unit<br>(include bracket + idler) | Rp. 863.000/set |
| 1.5 m Hand Crank                                     | Rp. 312.000/pcs |
| 2.0 m Hand Crank                                     | Rp. 375.000/pcs |
| 2.5 m Hand Crank                                     | Rp. 437.000/pcs |
| 3.0 m Hand Crank                                     | Rp. 500.000/pcs |

### HARGA SUDAH TERMASUK PPN

1. Minimum order monsoon chain HD with spring adalah lebar 1m x tinggi 1m = 1m<sup>2</sup>
2. Minimum lebar chain oversize adalah 157cm
3. Harga dickson + ongkos kerja /m<sup>2</sup> dari bahan PVC Clear yang digunakan = 54.000/m<sup>2</sup> (netto)
4. Biaya pemasangan Rp. 200.000/set

|  | BOX<br>OG<br>STANDARD | BOX OP<br>HEAVY DUTY<br>CURVED<br>SQUARE | FABRIC<br>ONLY<br>m <sup>1</sup> tinggi<br>[127 mm] |
|--|-----------------------|--|---|
| <b>SYSTEM/BOX ONLY</b><br>minimal order L 1.60 [T rantai max 1.70] | 215.000               | 295.000                                  | -   |
| <b>DIMOUT DELUXE SERIES</b>  |                       |  |   |
| 80   | 320.000               | 355.000                                  | 21.800  |
| 88   | 371.000               | 406.000                                  | 26.500  |
| 202 . 707 . 9002   | 408.000               | 443.000                                  | 28.000  |
| 303 . 505  | 464.000               | 499.000                                  | 30.000  |
| <b>DIMOUT SUPERIOR SERIES</b>                                      |                       |  |   |
| 111 . 222 . 777 . 606  | 477.000               | 512.000                                  | 33.000  |
| SP Baby, ERRA . REA . ECO  | 557.000               | 592.000                                  | 38.400  |
| <b>SEMI BLACK OUT &amp; BLACK OUT</b>                              |                       |  |   |
| 54   | 503.000               | 538.000                                  | 34.600  |
| <b>100% BLACK OUT</b>  |                       |  |   |
| 6045 . 6046 . 6077   | 514.000               | 549.000                                  | 35.400  |
| 6044 . 6066 . 6095 . 6028  | 593.000               | 628.000                                  | 40.800  |
| 6022 . 6027 . 6029 . 200 . EQ 35-6                                 | 716.000               | 751.000                                  | 49.400  |
| <b>100% BLACK OUT PREMIUM</b>                                      |                       |  |   |
| 3003 . 6027 . 6029 . 200Print                                      | 802.000               | 837.000                                  | 55.000  |
| <b>SUNSCREEN</b>   |                       |  |   |
| 2010   | 498.000               | 533.000                                  | 34.400  |
| 2600 . 4000  | 551.000               | 586.000                                  | 38.000  |
| SP View . 500 . 510 . HZ . VW                                      | 654.000               | 689.000                                  | 45.100  |
| SP 48-1% . 811 . SUNTEX 80 . 47HT                                  | 690.000               | 725.000                                  | 47.600  |
| DX61 . SUNTEX 90   | 728.000               | 763.000                                  | 50.200  |
| 8066 Alumunium Coating   | 1.040.000             | 1.075.000                                | 71.700  |
| <b>PLATINUM - fabrics by Serge Ferrari</b>                         |                       |  |   |
| S99 <Indoor>   S86 . S92 . S96 <Outdoor>                           | 1.001.000             | 1.036.000                                | 69.000  |
| S88 Alu LowE . S99 Alu LowE  | 1.120.000             | 1.155.000                                | 77.200  |
| W96 . FFSK20 Fire Shade  | 1.215.000             | 1.250.000                                | 83.800  |
| B92  | 1.840.000             | 1.875.000                                | 127.000   |
| Projector Screen   | 684.000               | 719.000                                  | 47.200  |



VERTICAL BLINDS  
WAND CONTROL+ CORD



PEMASANGAN POSISI MIRING

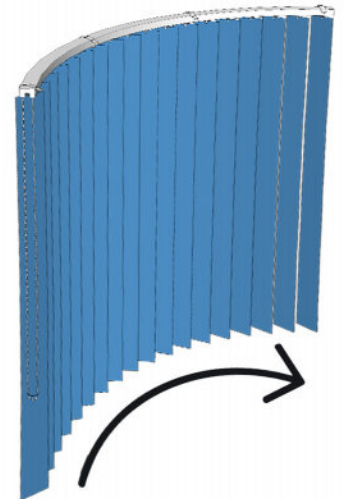

VERTICAL BLINDS  
CURVED TRACK

Rp. 2.180.000 /set

Rp. 400.000 /pcs

Rp. 788.000 /m<sup>1</sup>

### HARGA SUDAH TERMASUK PPN

1. System only 90mm / 127mm (rel saja + bracket) minimum order L 1.60, panjang rantai 1.7
2. Fabric only 90 / 127mm (kain saja, tanpa komponen) minimum order T 100cm
3. Set komplit minimum order L 100 x T 100 = 1m<sup>2</sup>
4. Fabric only 90mm harga +12% dari fabric only 127mm
5. Wand control system = komplit set +Rp 165.000/set
6. Posisi bidang miring = komplit set +Rp 146.000/m<sup>1</sup> lebar
7. Rel lengkung = komplit set +Rp 547.000/m<sup>1</sup> (harus menggunakan 90mm)
8. Biaya pemasangan Rp 11.000 (netto) minimal 15m<sup>2</sup>
9. Biaya service potong lebar Rp 35.000/set | potong tinggi Rp 35.000/m<sup>1</sup> tinggi
10. Minimum charge service Rp 60.000/set (tidak termasuk komponen)
11. Bottom weight Rp. 5.000/pcs
12. Bottom link chain Rp. 5.000/m<sup>1</sup>
13. Slat holder Rp. 2.000/pcs

|                               |     |                   |
|-------------------------------|-----|-------------------|
| Cover Plate                   | Rp. | 310.000/m lebar   |
| Head Rail Stainless Steel 202 | Rp. | 190.000/m lebar   |
| Stainless Steel Clasp 202     | Rp. | 53.000/pcs        |
| PVC Clear                     | Rp. | 210.000/m tinggi* |

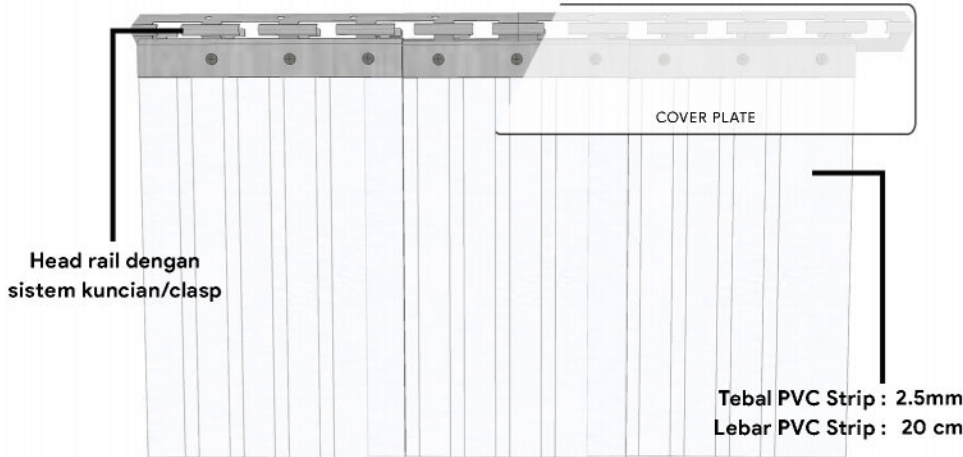

|                                     |     |                 |
|-------------------------------------|-----|-----------------|
| Top Track Stainless Steel           | Rp. | 130.000/m lebar |
| Slat Hanger Stainless Steel         | Rp. | 48.500/pcs      |
| PVC Strip Clear Magnet (lebar 35cm) | Rp. | 265.000/m lebar |
| Bottom Cover                        | Rp. | 44.000/pcs      |

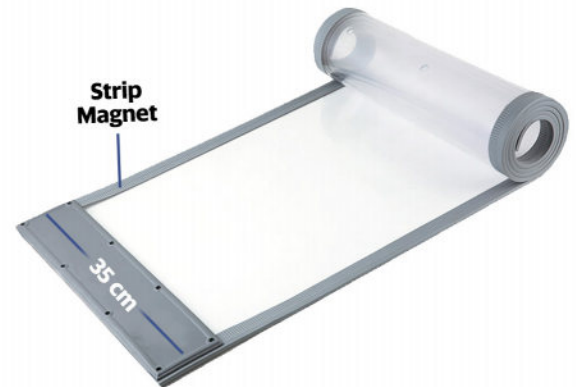

**HARGA SUDAH TERMASUK PPN**

1. \* = jumlah daun x meter linear tinggi
2. Biaya perakitan Rp. 70.000/m lebar (netto)
3. Biaya pemasangan daerah Jakarta = Rp 15.000/m<sup>2</sup> netto (minimal 15m<sup>2</sup>)



Ilustrasi gambar menggunakan ladder tape  
(lebih tebal)



Ilustrasi gambar menggunakan string tape  
(lebih tipis)

| Stick + Cord<br>27 mm<br>Tropical Hardwood | Pull Cord<br>35 mm<br>Tropical Hardwood | Pull Cord<br>50 mm<br>Tropical Hardwood |
|--|---|---|
|--|---|---|

|                    |                          |                          |                          |
|--------------------|--------------------------|--------------------------|--------------------------|
| Manual String Tape | 995.000/m <sup>2</sup>   | 1.080.000/m <sup>2</sup> | 1.225.000/m <sup>2</sup> |
| Manual Ladder Tape | 1.050.000/m <sup>2</sup> | 1.140.000/m <sup>2</sup> | 1.265.000/m <sup>2</sup> |

| Chain<br>27 mm<br>Tropical Hardwood | Chain<br>35 mm<br>Tropical Hardwood | Chain<br>50 mm<br>Tropical Hardwood |
|-------------------------------------|-------------------------------------|-------------------------------------|
|-------------------------------------|-------------------------------------|-------------------------------------|

|                                  |                          |                          |                          |
|----------------------------------|--------------------------|--------------------------|--------------------------|
| One Control Chain<br>String Tape | 1.082.000/m <sup>2</sup> | 1.427.000/m <sup>2</sup> | 1.628.000/m <sup>2</sup> |
| Ladder Tape                      | -/m <sup>2</sup>         | 1.500.000/m <sup>2</sup> | 1.750.000/m <sup>2</sup> |

Ladder Tape

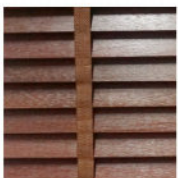

String Tape



### HARGA SUDAH TERMASUK PPN

1. Minimum order Wooden Blinds adalah 1.00m<sup>2</sup>  
(lebar dan tinggi kurang dari 1.00m tetap dihitung 1.00m)
2. Biaya pemasangan motorized system Rp. 250.000/set  
Biaya pemasangan wilayah Jakarta Rp. 11.000/m<sup>2</sup> minimum 15m<sup>2</sup> (Netto)  
Upgrade box 27mm ke 35mm (manual/pull cord) Rp. 50.000/m<sup>1</sup>
3. NOVO Motorized System > Halaman 12
4. Box 50 mm motorized > Halaman 12



**Venetian Blinds 25mm Manual**

|                    |                         |
|--------------------|-------------------------|
| Deluxe Slat        | 380.000 /m <sup>2</sup> |
| Perforated Slat    | 450.000 /m <sup>2</sup> |
| Wooden Motive Slat | 524.000 /m <sup>2</sup> |



**Venetian Blinds 50mm  
Manual Cord System**

|             |                        |
|-------------|------------------------|
| Deluxe Slat | 620.000/m <sup>2</sup> |
|-------------|------------------------|



**Venetian Blinds 25mm  
One Control Acrylic Stick**

|                    |                         |
|--------------------|-------------------------|
| Deluxe Slat        | 466.000 /m <sup>2</sup> |
| Perforated Slat    | 547.000 /m <sup>2</sup> |
| Wooden Motive Slat | 620.000 /m <sup>2</sup> |



**Fabric Venetian Blinds  
LANTEX 50mm Manual**

|             |                          |
|-------------|--------------------------|
| Fabric Slat | 1.330.000/m <sup>2</sup> |
|-------------|--------------------------|



**Venetian Blinds  
One Control Chain**

|                          |                          |
|--------------------------|--------------------------|
| 25 mm Deluxe Slat        | 466.000/m <sup>2</sup>   |
| 25 mm Perforated Slat    | 547.000/m <sup>2</sup>   |
| 25 mm Wooden Motive Slat | 620.000/m <sup>2</sup>   |
| 50 mm Deluxe Slat        | 890.000/m <sup>2</sup>   |
| 50 mm Lantex             | 1.420.000/m <sup>2</sup> |

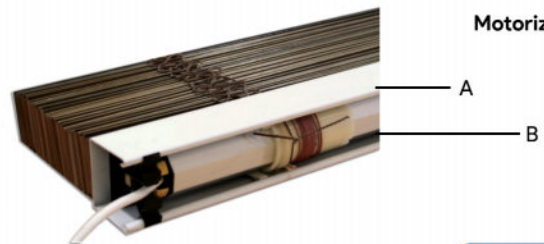

**Motorized System**

- A. Box 50mm Motorized
- B. Motorized by NOVO (include)  
-Receiver, Wall Switch, Remote 1 Channel

**Rp. 450.000/m<sup>1</sup>**

**Rp. 5.400.000/set**

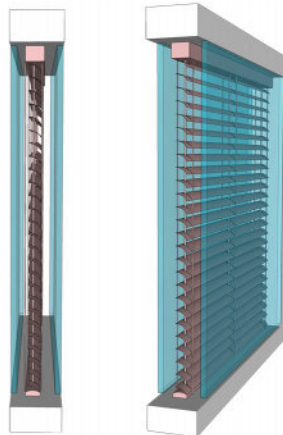

**16 mm Micro Venetian Blinds**

**Deluxe Slat Manual  
in- Glass + Frame (Magnetic System)  
Motorized System**

|                           |
|---------------------------|
| 514.000 /m <sup>2</sup>   |
| 2.400.000 /m <sup>2</sup> |
| <b>Rp. 5.200.000/set</b>  |

**HARGA SUDAH TERMASUK PPN**

1. Minimum order Venetian Blinds adalah 1.00m<sup>2</sup>  
(lebar dan tinggi kurang dari 1.00m tetap dihitung 1.00m)
2. **Biaya kombinasi**  
3 warna / lebih, harga per m<sup>2</sup> ditambah 10%  
5 warna / lebih, harga per m<sup>2</sup> ditambah 20%
3. Biaya pasang wilayah Jakarta : Rp 11.000/m<sup>2</sup> (netto) <minimal 15m<sup>2</sup>>
4. Biaya pasang motorized system : Rp 250.000/set (netto)



# 2022 PRICE LIST

# Panel Shade

5 Years Component Guarantee\*

| SYSTEM/BOX ONLY                          | 2 Track<br>Rp. / m <sup>1</sup> | 3 Track<br>Rp. / m <sup>1</sup> | 4 Track<br>Rp. / m <sup>1</sup> | 5 Track<br>Rp. / m <sup>1</sup> |
|--|---------------------------------|---------------------------------|---------------------------------|---------------------------------|
| Track Panel Shade<br>Pully / Wand System | 1.300.000                       | 1.515.000                       | 1.712.000                       | 1.910.000                       |

| FABRIC TYPE | FABRIC<br>ONLY |
|-------------|----------------|
|-------------|----------------|

### DIMOUT DELUXE SERIES

|                  |         |
|------------------|---------|
| 202 . 707 . 9002 | 289.000 |
| 303 . 505        | 329.000 |

### DIMOUT SUPERIOR SERIES

|                            |         |
|----------------------------|---------|
| 111 . 222 . 777 . 606      | 403.000 |
| SP Baby . ERRA . REA . ECO | 420.000 |

### SEMI BLACK OUT & BLACK OUT

|           |         |
|-----------|---------|
| 54 . 100B | 372.000 |
|-----------|---------|

### 100% BLACK OUT

|                                   |         |
|-----------------------------------|---------|
| 6045 . 6046 . 6077 . Green Screen | 366.000 |
| 6044 . 6055 . 6066 . 6095 . 6028  | 414.000 |
| 200 . 6022 . 6027 . 6029 . EQ35-6 | 456.000 |

### 100% BLACK OUT PREMIUM

|                 |         |
|-----------------|---------|
| 3003 . 200Print | 610.000 |
|-----------------|---------|

### SUNSCREEN

|                               |         |
|-------------------------------|---------|
| 2010                          | 353.000 |
| 2600 . 4000                   | 385.000 |
| SP View . 500 . 510 . HZ . VW | 456.000 |
| SP 48-1% . 811                | 507.000 |

### SUNSCREEN OUTDOOR

|                         |         |
|-------------------------|---------|
| PHIFER Suntex 80 . 47HT | 519.000 |
| PHIFER Suntex 90 . DX61 | 546.000 |

### SUNSCREEN FIBERGLASS

|                        |         |
|------------------------|---------|
| 8066 Alumunium Coating | 960.000 |
|------------------------|---------|

### ART PATTERN

|                     |         |
|---------------------|---------|
| PP . PJ . PR        | 466.000 |
| Glass Film 60 - 80% | 562.000 |

### ART PATTERN PREMIUM

|                         |         |
|-------------------------|---------|
| APJ Series . APP Series | 662.000 |
|-------------------------|---------|

### fabrics by Serge Ferrari

|  |           |
|--|-----------|
| S99 <Indoor>   S86 . S92 . S96 <Outdoor> | 900.000   |
| S88 Alu LowE . S99 Alu LowE              | 920.000   |
| W96 . FFSK20 Fire Shade                  | 1.200.000 |
| B92                                      | 1.525.000 |

### OUTDOOR

|                                |         |
|--------------------------------|---------|
| Dickson Orchestra by Glenraven | 850.000 |
| Mehler Valmax                  | 845.000 |
| Arashi                         | 660.000 |
| Projector Screen               | 550.000 |

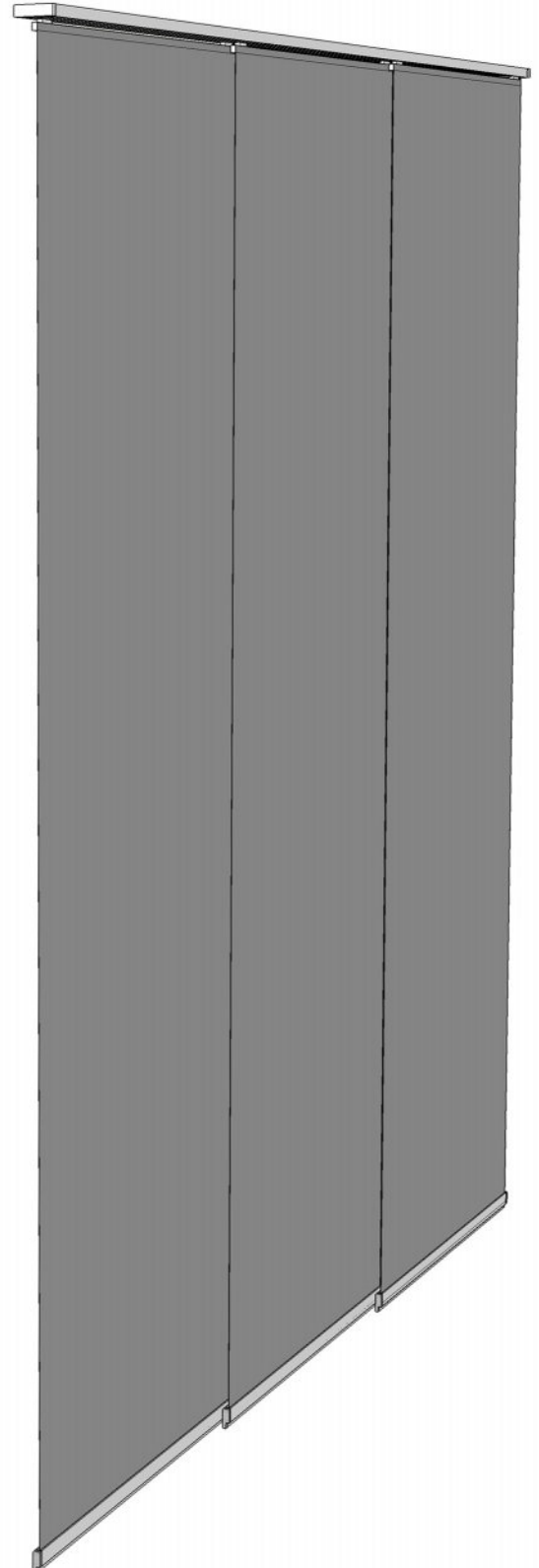

### HARGA SUDAH TERMASUK PPN

1. Pemesanan set komplet minimum charge lebar 100 cm & tinggi 160 cm = 1.60m<sup>2</sup>
2. Biaya pemasangan daerah Jakarta = Rp. 11.000/m<sup>2</sup> (minimal 15m<sup>2</sup>)





**Fabric Type**

**Single System - Single Layer**

**Single System - Double Layer**

Black Out  
Semi Black Out  
Dim Out / Sheer / Translucent

1.170.000 /m<sup>2</sup>  
1.087.000 /m<sup>2</sup>  
1.190.000 /m<sup>2</sup>

1.860.000 /m<sup>2</sup>  
1.726.000 /m<sup>2</sup>  
1.860.000 /m<sup>2</sup>



**Fabric Type**

**Double System - Single Layer**

**Double System - Double Layer**

Black Out  
Semi Black Out  
Dim Out / Sheer / Translucent

1.390.000 /m<sup>2</sup>  
1.315.000 /m<sup>2</sup>  
1.390.000 /m<sup>2</sup>

2.010.000 /m<sup>2</sup>  
1.960.000 /m<sup>2</sup>  
2.010.000 /m<sup>2</sup>

**HARGA SUDAH TERMASUK PPN**

1. Minimum order Honeycomb adalah 1.00m<sup>2</sup>  
(lebar dan tinggi kurang dari 1m dihitung 1m)
2. Biaya pemasangan daerah Jakarta = Rp. 11.000/m<sup>2</sup> netto (minimal 15m<sup>2</sup>)

Panjang / Length / Kedepan

| Lebar / Width | 0-2.00     | 2.01-3.00  | 3.01-4.00  | 4.01-5.00  | 5.01-6.00  | 6.01-7.00  | 7.01-8.00  |
|---------------|------------|------------|------------|------------|------------|------------|------------|
| s/d 1.50      | 7.613.000  | 7.784.000  | 7.967.000  | 8.370.000  | 8.540.000  | 8.723.000  | 9.187.000  |
| 1.51 s/d 2.00 | 8.272.000  | 8.443.000  | 8.614.000  | 9.077.000  | 9.248.000  | 9.419.000  | 9.895.000  |
| 2.01 s/d 2.50 | 8.931.000  | 9.102.000  | 9.272.000  | 9.748.000  | 9.919.000  | 10.090.000 | 10.566.000 |
| 2.51 s/d 3.00 | 10.236.000 | 10.480.000 | 10.712.000 | 11.237.000 | 11.468.000 | -          | -          |

















### Fabrics

|                                     |                             |
|-------------------------------------|-----------------------------|
| Serge Ferrari S86, S96, S92         | Rp. 900.000 /m <sup>2</sup> |
| Serge Ferrari 501                   | Rp. 828.000 /m <sup>2</sup> |
| Serge Ferrari 702 S2                | Rp. 945.000 /m <sup>2</sup> |
| AGTex 751                           | Rp. 520.000 /m <sup>2</sup> |
| AGTex 951                           | Rp. 600.000 /m <sup>2</sup> |
| Mehler                              | Rp. 845.000 /m <sup>2</sup> |
| Dickson Orchestra (lebar max 1.20m) | Rp. 850.000 /m <sup>2</sup> |
| DX-61                               | Rp. 546.000 /m <sup>2</sup> |
| Suntex 80                           | Rp. 519.000 /m <sup>2</sup> |
| Suntex 90                           | Rp. 546.000 /m <sup>2</sup> |

### Components

|                               |                            |
|-------------------------------|----------------------------|
| Double Wire 2.0 mm            | Rp. 49.000 /m <sup>1</sup> |
| Double Wire 2.5 mm            | Rp. 64.000 /m <sup>1</sup> |
| Directional Pulley (2pcs/set) | Rp. 220.000 /set           |

### Motorized System

|   |                     |
|---|---------------------|
|  SOMFY Altus 50 RTS 10/32   | Rp. 9.360.000 /set  |
|  SOMFY Altus 50 RTS 40/17   | Rp. 12.200.000 /set |
|  SOMFY Altus 60 RTS 85/17   | Rp. 19.200.000 /set |
|  SOMFY Altus 60 RTS 100/12  | Rp. 22.500.000 /set |
|  SOMFY Altus 60 RTS 120/12  | Rp. 24.200.000 /set |
|  SOMFY Sonesse 50 RTS 15/17 | Rp. 15.300.000 /set |
|  SHARP POINT RTS 10/28      | Rp. 3.500.000 /set  |
|  SHARP POINT RTS 40/12      | Rp. 4.250.000 /set  |
|  SHARP POINT 59 WT 100/12   | Rp. 6.700.000 /set  |
|  NOVO K-45-EL 50/12         | Rp. 3.500.000 /set  |
|  DOOYA DM-45-M 50/12        | Rp. 3.800.000 /set  |
|  CHERUBINI Roll 40/17       | Rp. 5.100.000 /set  |
|  CHERUBINI Senso RX 15/30   | Rp. 9.650.000 /set  |
|  CHERUBINI Wave RX 85/17    | Rp. 13.850.000 /set |

### Motorized Control & Components

|                              |                    |
|------------------------------|--------------------|
| SOMFY Remote Situo RTS 1 Ch  | Rp. 985.000 /set   |
| SOMFY Remote Situo 1 Ch      | Rp. 1.345.000 /set |
| SOMFY Remote Situo 2 Ch      | Rp. 1.995.000 /set |
| SOMFY Remote Situo 5 Ch      | Rp. 2.400.000 /set |
| SOMFY Telis 16 RTS Pure Intl | Rp. 8.300.000 /set |
| Connexoon RTS                | Rp. 6.500.000 /set |
| Smooove Origin RTS           | Rp. 1.580.000 /set |
| Telis Silver 1 Ch            | Rp. 1.850.000 /set |
| Telis Silver 4 Ch            | Rp. 2.950.000 /set |
| Cherubini Remote 1 Ch        | Rp. 1.900.000 /set |
| Cherubini Remote 5 Ch        | Rp. 2.100.000 /set |
| Sharp Point Remote 1-5 Ch    | Rp. 720.000 /set   |
| Novo Receiver                | Rp. 660.000 /set   |
| Novo Remote 1-5 Ch           | Rp. 660.000 /set   |
| Dooya Receiver               | Rp. 660.000 /set   |
| Dooya Remote                 | Rp. 490.000 /set   |

### HARGA SUDAH TERMASUK PPN

1. Biaya pemasangan daerah Jakarta : Rp. 250.000/set (netto)
  2. Biaya pemasangan Bodetabek : Rp. 450.000/set (netto)
- Biaya pemasangan belum termasuk steger, konstruksi, sipil dan instalasi listrik tambahan

|       |               | Panjang / Length / Kedepan |            |            |            |            |            |
|-------|---------------|----------------------------|------------|------------|------------|------------|------------|
|       |               | 0-2.00                     | 2.01-3.00  | 3.01-4.00  | 4.01-5.00  | 5.01-6.00  | 6.01-7.00  |
| Lebar | s/d 1.50      | 8.199.000                  | 9.004.000  | 9.797.000  | 10.602.000 | 12.213.000 | 13.396.000 |
|       | 1.51 s/d 2.00 | 9.248.000                  | 10.053.000 | 10.858.000 | 12.762.000 | 13.945.000 | 15.128.000 |
|       | 2.01 s/d 2.50 | 11.908.000                 | 13.091.000 | 14.274.000 | 15.458.000 | 18.105.000 | 19.081.000 |
|       | 2.51 s/d 3.00 | 15.494.000                 | 17.068.000 | 18.654.000 | 20.228.000 | 21.802.000 | 23.388.000 |

|       |               | Panjang / Length / Kedepan |            |            |             |             |             |
|-------|---------------|----------------------------|------------|------------|-------------|-------------|-------------|
|       |               | 7.01-8.00                  | 8.01-9.00  | 9.01-10.00 | 10.01-11.00 | 11.01-12.00 | 12.01-13.00 |
| Lebar | s/d 1.50      | 14.579.000                 | 15.702.000 | 16.958.000 | 18.142.000  | 19.325.000  | 20.509.000  |
|       | 1.51 s/d 2.00 | 16.312.000                 | 17.495.000 | 19.545.000 | 21.119.000  | 22.705.000  | 24.278.000  |
|       | 2.01 s/d 2.50 | 20.667.000                 | 22.241.000 | 23.827.000 | 25.401.000  | 26.987.000  | 28.451.000  |
|       | 2.51 s/d 3.00 | 24.962.000                 | 26.535.000 | 28.121.000 | 29.707.000  | 31.281.000  | 32.855.000  |

Manual control mechanism spring Rp. 1.721.000/set

Backing Bar SLR Rp. 147.000/m<sup>1</sup>

Hanger SLR Rp. 135.000/pes



#### HARGA SUDAH TERMASUK PPN

1. Harga diatas adalah harga komplet set (system only)
2. Jarak backing bar minimum : 60 cm
3. Jarak backing bar maksimum : 100 cm
4. Harga kain/fabric tertera di halaman 1 (fabric only)
5. Upgrade ke motorized system, penambahan sesuai dengan penggunaan jenis motor (*lihat halaman 4*)
6. Biaya pemasangan daerah Jakarta : Rp. 250.000/set (netto)
7. Biaya pemasangan Bodetabek : Rp. 450.000/set (netto)  
(biaya pemasangan belum termasuk steger, konstruksi, sipil dan instalasi listrik tambahan)

|  | CHAIN DELUXE<br>/ PULL CORD<br>(TANPA PONI) | CHAIN DELUXE<br>/ PULL CORD<br>(DENGAN PONI) |
|--|---|--|
| <b>DIMOUT DELUXE SERIES</b>              |   |  |
| 202 . 707 . 9002                         | 607.000                                     | 679.000                                      |
| 303 . 505                                | 658.000                                     | 740.000                                      |
| <b>DIMOUT SUPERIOR SERIES</b>            |   |  |
| 111 . 222 . 777 . 606                    | 672.000                                     | 772.000                                      |
| SP Baby . ERRA . REA . ECO               | 740.000                                     | 845.000                                      |
| <b>SEMI BLACK OUT &amp; BLACK OUT</b>    |   |  |
| 54 . 100B                                | 695.000                                     | 788.000                                      |
| <b>100% BLACK OUT</b>                    |   |  |
| 6045 . 6046 . 6077                       | 690.000                                     | 781.000                                      |
| 6044 . 6055 . 6066 . 6095 . 6028         | 774.000                                     | 877.000                                      |
| 200 . 6022 . 6027 . 6029 . EQ35-6        | 882.000                                     | 996.000                                      |
| <b>100% BLACK OUT PREMIUM</b>            |   |  |
| 3003 . 200Print                          | 955.000                                     | 1.107.000                                    |
| <b>SUNSCREEN</b>                         |   |  |
| 2010                                     | 688.000                                     | 776.000                                      |
| 2600 . 4000                              | 728.000                                     | 824.000                                      |
| SP View . 500 . 510 . HZ . VW            | 826.000                                     | 940.000                                      |
| SP 48-1% . 811                           | 860.000                                     | 986.000                                      |
| PHIFER Suntex 80 . 47HT                  | 912.000                                     | 1.041.000                                    |
| PHIFER Suntex 90 . DX61                  | 1.040.000                                   | 1.176.000                                    |
| <b>SUNSCREEN FIBERGLASS</b>              |   |  |
| 8066 Alumunium Coating                   | 1.265.000                                   | 1.500.000                                    |
| <b>ART PATTERN</b>                       |   |  |
| PP . PJ . PR                             | 865.000                                     | 981.000                                      |
| <b>ART PATTERN PREMIUM</b>               |   |  |
| APJ series . APP series                  | 1.058.000                                   | 1.220.000                                    |
| <b>fabrics by Serge Ferrari</b>          |   |  |
| S99 <Indoor>   S86 . S92 . S96 <Outdoor> | 1.335.000                                   | 1.560.000                                    |
| S88 Alu LowE . S99 Alu LowE              | 1.470.000                                   | 1.700.000                                    |
| W96 . FFSK20 Fire Shade                  | 1.642.000                                   | 1.900.000                                    |
| B92                                      | 1.977.000                                   | 2.300.000                                    |
| <b>OTHERS</b>                            |   |  |
| Dickson Orchestra by Glenraven           | 1.268.000                                   | 1.480.000                                    |
| Arashi                                   | 1.056.000                                   | 1.221.000                                    |
| Projector Screen                         | 929.000                                     | 1.066.000                                    |



CHAIN DELUXE  
/ PULL CORD  
(TANPA PONI)



CHAIN DELUXE / PULL CORD  
(DENGAN PONI)

TIPE PONI ROMAN BAR DAPAT DISESUAIKAN SESUAI REFERENSI ANDA\*

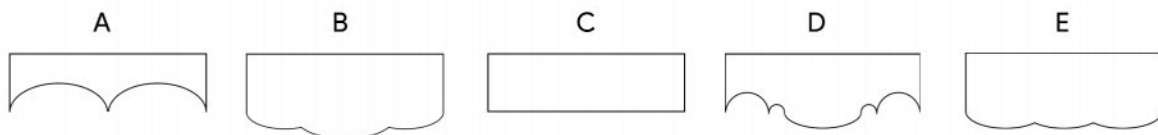

### HARGA SUDAH TERMASUK PPN

1. Minimum order Sharp Point Roman Bars adalah 1m<sup>2</sup>  
(lebar & tinggi kurang dari 1m dihitung 1m)
2. Minimum Order Sharp Point Roman Bamboo adalah 1m<sup>2</sup>  
(lebar & tinggi kurang dari 1m dihitung 1m)
3. System Chain HD ditambah Rp 108.000/m<sup>1</sup> lebar
4. Biaya pemasangan wilayah Jakarta Rp 11.000/m<sup>2</sup> netto min 15m<sup>2</sup>

### \*Roman Shade Chain Deluxe Drum Plus

Rail Set 418.000 /m'  
Paket 10 Batang + Isi 19.170.000 /paket

#### Isi Paket

|                           |        |                 |         |
|---------------------------|--------|-----------------|---------|
| Aluminium head rail @5.8m | 10 btg | Bracket (white) | 120 pcs |
| Magic tape                | 60 m   | Drum            | 120 pcs |
| Control unit set          | 60 set | Cord ring       | 500 pcs |
| Tilt rod @5.8m            | 10 btg | Operation Chain | 200 m   |
| PVC shapper               | 180 m  | Connector       | 60 pcs  |
| PVC bottom rail           | 60 m   | Stop ring       | 60 pcs  |
| Nylon cord 1.4mm          | 500 m  |                 |         |



### Roman Shade Chain Heavy Duty

Rail Set 493.000 /m'  
Paket 10 Batang + Isi 22.572.000 /paket

#### Isi Paket

|                           |        |                 |         |
|---------------------------|--------|-----------------|---------|
| Aluminium head rail @5.8m | 10 btg | Bracket (white) | 120 pcs |
| Magic tape                | 60 m   | Drum            | 120 pcs |
| Control unit set          | 60 set | Cord ring       | 500 pcs |
| Tilt rod @5.8m            | 10 btg | Operation Chain | 200 m   |
| PVC shapper               | 180 m  | Connector       | 60 pcs  |
| PVC bottom rail           | 60 m   | Stop ring       | 60 pcs  |
| Nylon cord 1.4mm          | 500 m  |                 |         |



### Roman Shade Chain Self Released

Rail Set 472.000 /m'  
Paket 10 Batang + Isi 22.275.000 /paket

#### Isi Paket

|                           |        |                 |         |
|---------------------------|--------|-----------------|---------|
| Aluminium head rail @5.8m | 10 btg | Bracket (white) | 120 pcs |
| Magic tape                | 60 m   | Drum            | 120 pcs |
| Control unit set          | 60 set | Cord ring       | 500 pcs |
| Tilt rod @5.8m            | 10 btg | Operation Chain | 200 m   |
| PVC shapper               | 180 m  | Connector       | 60 pcs  |
| PVC bottom rail           | 60 m   |                 |         |
| Nylon cord 1.4mm          | 500 m  |                 |         |



### Roman Shade Pull Cord

Rail Set 428.000 /m'  
Paket 10 Batang + Isi 19.553.000 /paket

#### Isi Paket

|                           |        |           |         |
|---------------------------|--------|-----------|---------|
| Aluminium head rail @5.8m | 10 btg | Tassel    | 120 pcs |
| Magic tape                | 60 m   | Bracket   | 120 pcs |
| Control unit set          | 60 set | Drum      | 120 pcs |
| PVC shapper               | 180 m  | Cord Ring | 500 pcs |
| PVC bottom rail           | 60 m   |           |         |
| Nylon cord 1.4mm          | 500 m  |           |         |
| Nylon cord 2.2mm          | 50 m   |           |         |



### Roman Shade Double Cord

Rail Set 601.000 /m'  
Paket 10 Batang + Isi 25.650.000 /paket

#### Isi Paket

|                           |         |           |          |
|---------------------------|---------|-----------|----------|
| Aluminium head rail @5.8m | 10 btg  | Tassel    | 240 pcs  |
| Magic tape                | 120 m   | Bracket   | 120 pcs  |
| Control unit set          | 120 set | Drum      | 240 pcs  |
| PVC shapper               | 360 m   | Cord Ring | 1000 pcs |
| PVC bottom rail           | 120 m   |           |          |
| Nylon cord 1.4mm          | 1000 m  |           |          |
| Nylon cord 2.2mm          | 100 m   |           |          |



### HARGA SUDAH TERMASUK PPN

1. Minimum order Roman Shade adalah 1m'
2. (Lebar dan tinggi kurang dari 1,00m tetap dihitung 1.00)
3. Backing bar PVC 26.000/m'  
Backing bar Aluminium 41.000/m'
4. Biaya pemasangan wilayah Jakarta Rp 11.000/m' (min 15m')
5. \*Metal connector Roman Chain Deluxe 90° Rp. 250.000/pcs
6. Roman Shade Motorized with 50 mm box (NOVO Motor, Receiver, Remote 1 Ch) **Rp. 5.500.000/set**
7. 50 mm box (for motorized) **Rp. 405.000/m'**

End cup 3.900/pcs  
Ring bar 4.700/pcs

| Fabric Type        | Chain Deluxe<br>Rp/m <sup>2</sup> | Pull Cord<br>Rp/m <sup>2</sup> | Chain HD<br>Rp/m <sup>2</sup> | Self Release<br>Rp/m <sup>2</sup> |
|--------------------|-----------------------------------|--------------------------------|-------------------------------|-----------------------------------|
| Fiore              | 594.000                           | 612.000                        | 682.000                       | 670.000                           |
| Almaz              | 707.000                           | 725.000                        | 782.000                       | 768.000                           |
| Pastel             | 619.000                           | 637.000                        | 707.000                       | 695.000                           |
| Wish / Dream       | 732.000                           | 750.000                        | 807.000                       | 795.000                           |
| Ferre - Velmo      | 853.000                           | 870.000                        | 940.000                       | 928.000                           |
| Ferre - Lisa       | 888.000                           | 903.000                        | 975.000                       | 963.000                           |
| Ferre - Lindra     | 888.000                           | 903.000                        | 975.000                       | 963.000                           |
| Ferre - Lizzo      | 963.000                           | 978.000                        | 1.048.000                     | 1.034.000                         |
| Ferre - Aldo       | 963.000                           | 978.000                        | 1.048.000                     | 1.034.000                         |
| Snow - V1          | 463.000                           | 480.000                        | 550.000                       | 538.000                           |
| Snow - V2          | 497.000                           | 505.000                        | 584.000                       | 572.000                           |
| Snow - V3          | 534.000                           | 550.000                        | 622.000                       | 609.000                           |
| Ferre - Shine SH 1 | 492.000                           | 508.000                        | 579.000                       | 568.000                           |
| Ferre - Shine SH 2 | 478.000                           | 494.000                        | 565.000                       | 553.000                           |
| Ferre - Shine SH 3 | 534.000                           | 554.000                        | 622.000                       | 609.000                           |
| Ferre - Shine SH 4 | 473.000                           | 490.000                        | 560.000                       | 548.000                           |
| Boston - Harvard   | 640.000                           | 660.000                        | 720.000                       | 712.000                           |
| Boston - Fenway    | 685.000                           | 704.000                        | 761.000                       | 757.000                           |
| Boston - Quincy    | 715.000                           | 734.000                        | 790.000                       | 788.000                           |

TIPE PONI ROMAN SHADE DAPAT  
DISESUAIKAN SESUAI REFERENSI ANDA\*

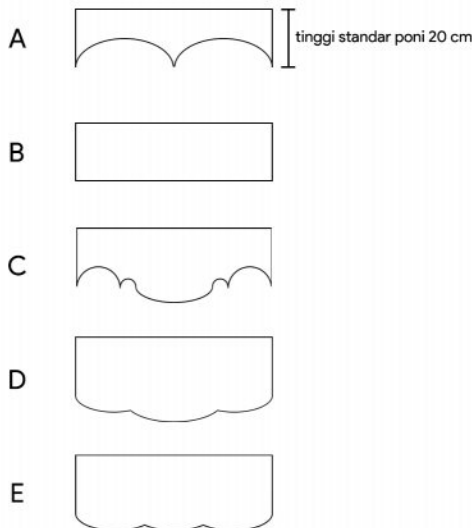

Roman Shade Chain System



Roman Shade Pull Cord

Harga poni = Harga fabric/m<sup>2</sup> x 20% x Lebar

### HARGA SUDAH TERMASUK PPN

1. Minimum order Roman Shade + fabric single shade adalah 1m'
2. (Lebar dan tinggi kurang dari 1,00m tetap dihitung 1.00)
3. Backing bar PVC 26.000/m'  
Backing bar Alumunium 41.000/m'
4. Biaya pemasangan wilayah Jakarta Rp 11.000/m<sup>2</sup> (min 15m<sup>2</sup>)
5. \*Metal connector Roman Chain Deluxe 90° Rp. 250.000/pcs
6. Roman Shade Motorized with 50 mm box (NOVO Motor, Receiver, Remote 1 Ch) **Rp. 5.500.000/set**
7. 50 mm box (for motorized) **Rp. 405.000/m'**
8. Kain double shade = harga single shade x 1.7x
9. Penambahan furing Rp 100.000/m<sup>2</sup> (netto; termasuk jahit)

End cup 3.900/pcs  
Ring bar 4.700/pcs

**Low Profile H&H <CT HEAD RAIL>**

**Standard Carrier**

**G Carrier**

**COLORS**  
Brown ●  
Silver ○  
White ○

Harga per meter <INC. STANDARD CARRIER> 125.000  
 Harga per batang 550.000  
 Harga paket (20btg) 9.100.000

**High Profile H&H <CT HEAD RAIL>**

**Standard Carrier**

**G Carrier**

**COLORS**  
White ○

Harga per meter <INC. STANDARD CARRIER> 150.000  
 Harga per batang 720.000  
 Harga paket (20btg) 12.000.000

**Silent PVC Strip <CT HEAD RAIL>**

**Standard Carrier**

**G Carrier**

**COLORS**  
White ○

**Silent PVC Strip (inside)**

Harga per meter <INC. STANDARD CARRIER> 156.000  
 Harga per batang 765.000  
 Harga paket (20btg) 13.770.000

### Hospital Track Component Guide

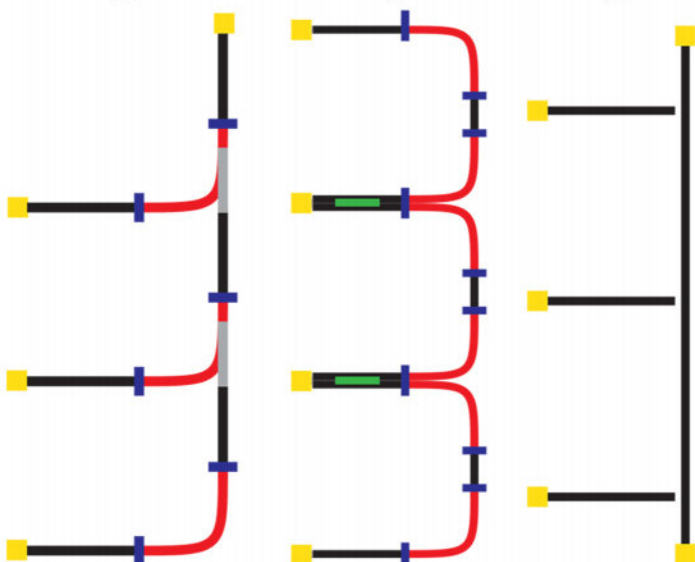

**1 Batang <CT HEAD RAIL> + isi**

|                         |           |
|-------------------------|-----------|
| Curtain Rail            | 6 m'      |
| Carrier Standard / Roda | 60 pcs    |
| End Cup Plastic         | 6 pcs     |
| Bracket Single / Double | 6 / 3 pcs |

**H&H Curved Rail**

|                         |             |
|-------------------------|-------------|
| H&H Curved Rail 45 LP   | 146.000/pcs |
| H&H Curved Rail 90 LP   | 204.000/pcs |
| H&H Curved Rail 45 HP   | 210.000/pcs |
| H&H Curved Rail 90 HP   | 285.000/pcs |
| H&H Curved Rail 45 SPVC | 181.000/pcs |
| H&H Curved Rail 90 SPVC | 251.000/pcs |

**Connecting Pipe**

|                          |             |
|--------------------------|-------------|
| Connecting Pipe 35-60cm  | 152.000/pcs |
| Connecting Pipe 55-100cm | 164.000/pcs |
| Connecting Pipe 75-140cm | 198.000/pcs |

**Standard Carrier**

2.550/pcs

**G Carrier**

10.000/pcs

**Wall "U" Bracket**

30.000/pcs

**Single Ceiling Bracket**

12.500/pcs

**Double Ceiling Bracket**

28.000/pcs

**Master Carrier (Overlap)**

62.000/set

**Single Wall Bracket**

12.500/pcs

**Double Wall Bracket**

28.000/pcs

**Joint Inside**

21.500/pcs

**Short Ceiling Bracket**

25.500/pcs

**Long Bracket**

44.500/pcs

**End Cup**

6.300/pcs

**Double Rail Connector**

58.500/pcs

**Curved Connector**

65.000/pcs

**Controller + End Cup Set**

48.000/set

**Rel lengkung 90° tanpa sambungan** 140.000/titik  
**Rel lengkung mal** harga 2.5x harga per meter/m

**HARGA SUDAH TERMASUK PPN**

1. Pemesanan set komplet minimum charge lebar 100 cm
2. Biaya pemasangan daerah Jakarta = Rp. 11.000/m' (minimal 15m')

## Flexi Track CT

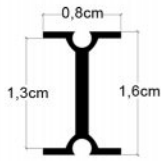

Manual Wand

|                           | Silver     | White/Black | Cream      |
|---------------------------|------------|-------------|------------|
| Harga per meter (komplit) | 140.000    | 150.000     | 170.000    |
| Harga per batang (kosong) | 265.000    | 325.000     | 350.000    |
| Harga per batang + isi    | 570.000    | 630.000     | 665.000    |
| Harga paket + isi (20btg) | 10.000.000 | 11.080.000  | 12.600.000 |

### 1 Batang <CT HEAD RAIL> + isi

|                         |           |
|-------------------------|-----------|
| Curtain Rail            | 6 m       |
| Carrier Standard / Roda | 60 pcs    |
| End Cup Plastic         | 6 pcs     |
| Bracket Single / Double | 6 / 3 pcs |

### Harga komponen satuan

|                         |              |
|-------------------------|--------------|
| Carrier Standard / Roda | 4.700 / pcs  |
| End Cup Plastic         | 5.800 / pcs  |
| Bracket Single          | 10.500 / pcs |
| Bracket Double          | 25.000 / pcs |

## Flexi Track ST

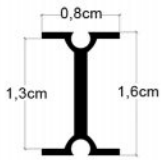

Manual Wand

|                           | Silver     | White      | Cream      |
|---------------------------|------------|------------|------------|
| Harga per meter (komplit) | 360.000    | 385.000    | 395.000    |
| Harga per batang (kosong) | 265.000    | 325.000    | 350.000    |
| Harga per batang + isi    | 1.550.000  | 1.630.000  | 1.700.000  |
| Harga paket + isi (20btg) | 24.000.000 | 25.300.000 | 27.000.000 |

### 1 Batang <ST HEAD RAIL> + isi

|  |         |
|--|---------|
| Curtain Rail                           | 6 m     |
| Ripple Carrier                         | 96 pcs  |
| Ripple Hook Single                     | 90 pcs  |
| Ripple Hook Double                     | 6 pcs   |
| Link Chain ST Carrier                  | 6 m     |
| Ripple Tape                            | 12 m    |
| End Cup Plastik                        | 6 pcs   |
| Bracket Single / Double (ceiling/wall) | 6/3 pcs |

### Harga komponen satuan

|                               |              |
|-------------------------------|--------------|
| Ripple Carrier                | 5.050 / pcs  |
| Ripple Hook Single            | 2.550 / pcs  |
| Ripple Hook Double            | 3.800 / pcs  |
| Link Chain ST Carrier         | 8.900 / m    |
| Ripple Tape                   | 47.000 / m   |
| End Cup Plastik               | 6.300 / pcs  |
| Bracket Single (ceiling/wall) | 11.400 / pcs |
| Bracket Double (ceiling/wall) | 28.000 / pcs |

## Flexi Track HD

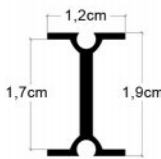

Manual Wand

Dapat menggunakan komponen H&H dan carrier "G"

|   | Cream      |
|---|------------|
| Harga per meter (komplit) <INC. STANDARD CARRIER> | 198.000    |
| Harga per batang (kosong)                         | 440.000    |
| Harga per batang + isi                            | 824.000    |
| Harga paket + isi (20btg)                         | 13.300.000 |

### 1 Batang <CT HEAD RAIL> + isi

|                         |           |
|-------------------------|-----------|
| Curtain Rail            | 6 m       |
| Carrier / Roda          | 60 pcs    |
| End Cup Plastik         | 6 pcs     |
| Bracket Single / Double | 6 / 3 pcs |

### Harga komponen satuan

|                                       |              |
|---------------------------------------|--------------|
| Carrier/ Roda                         | 6.300 / pcs  |
| End Cup Plastik                       | 6.300 / pcs  |
| Bracket Single                        | 15.200 / pcs |
| Bracket Double                        | 70.000 / pcs |
| Bracket Short                         | 20.500 / pcs |
| Bracket Long                          | 51.000 / pcs |
| Join Track                            | 21.600 / m   |
| Long Rail Holder Flexi HD             | 82.000 / pcs |
| Wall Bracket "U"                      | 28.000 / pcs |
| Carrier "G"                           | 19.000 / pcs |
| Double Rail Holder / Double Connector | 54.000 / pcs |

## HARGA SUDAH TERMASUK PPN

1. Minimum order Flexi Track adalah lebar 1m
2. Manual system tidak termasuk master carrier / overlap arm
3. Biaya pemasangan wilayah Jakarta Rp 11.000/m' (min 15m')
4. Alat lengkung rel Flexi Standar 800.000 / pcs (netto)
5. Alat lengkung rel Flexi HD 1.200.000 / pcs (netto)





Harga per meter <INC. STANDARD CARRIER>  
 Harga per batang  
 Harga paket (20btg)

| White / Brown | EP Cream   |
|---------------|------------|
| 140.000       | 215.000    |
| 645.000       | 980.000    |
| 11.300.000    | 18.000.000 |

| 1 Batang <CT HEAD RAIL> + isi |           |
|-------------------------------|-----------|
| Curtain Rail                  | 6 m       |
| Carrier Standard / Roda       | 60 pcs    |
| End Cup Plastic               | 6 pcs     |
| Bracket Single / Double       | 6 / 3 pcs |

| Harga komponen satuan         |             |
|-------------------------------|-------------|
| Carrier/ Roda                 | 3.800 /pcs  |
| End Cup Plastic               | 13.000 /pcs |
| Bracket Single (Ceiling/Wall) | 13.000 /pcs |
| Bracket Double (Ceiling/Wall) | 31.000 /pcs |
| Controller + End Cup Set      | 82.500 /set |
| Master Carrier + Overlap Arm  | 67.000 /pcs |
| Nylon Cord High Tension 2.2mm | 2.600 /m    |
| Tension Pully                 | 70.000 /pcs |
| Cord Weight                   | 28.000 /pcs |



Harga per meter <INC. STANDARD CARRIER>  
 Harga per batang  
 Harga paket (20btg)

| White / Brown | EP Cream   |
|---------------|------------|
| 490.000       | 520.000    |
| 1.950.000     | 2.150.000  |
| 34.500.000    | 38.000.000 |

| 1 Batang <ST HEAD RAIL> + isi       |           |
|-------------------------------------|-----------|
| Curtain Rail                        | 6 m       |
| End Cup Plastic                     | 6 pcs     |
| Bracket Single / Double             | 6 / 3 pcs |
| Ripple Carrier                      | 96 pcs    |
| Ripple Hook Single                  | 90 pcs    |
| Ripple Hook Double                  | 6 pcs     |
| Link Chain for Carrier ST 6cm / 8cm | 6 m       |
| Ripple Tape 12.5cm / 14.5cm         | 14 m      |

| Harga komponen satuan            |             |
|----------------------------------|-------------|
| End Cup Plastic                  | 13.000 /pcs |
| Bracket Single (Ceiling/Wall)    | 13.000 /pcs |
| Bracket Double (Ceiling/Wall)    | 31.000 /pcs |
| Controller + End Cup Set         | 82.500 /set |
| Master Carrier +Pully Set        | 55.000 /set |
| Ripple Carrier                   | 5.050 /pcs  |
| Ripple Hook Single               | 2.550 /pcs  |
| Ripple Hook Double               | 3.800 /pcs  |
| Link Chain for Carrier 6cm / 8cm | 8.900 /m    |
| Ripple Tape 12.5cm / 14.5cm      | 47.000 /m   |
| Nylon Cord HT 2.2mm              | 2.600 /m    |
| Tension Pully                    | 70.000 /pcs |
| Cord Weight                      | 28.000 /pcs |

### HARGA SUDAH TERMASUK PPN

1. Minimum order 82 Track adalah lebar 1m
2. Manual system tidak termasuk master carrier / overlap arm
3. Biaya pemasangan wilayah Jakarta Rp 11.000/m' (min 15m')
4. Biaya rel Lengkung 2.5x harga per meter (hanya untuk 82 EP Cream)

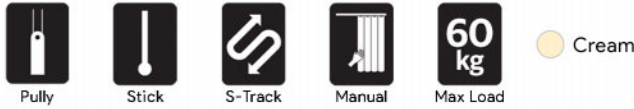
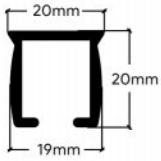

Harga per meter <INC. STANDARD CARRIER>  
 Harga per batang  
 Harga paket (20btg)

|   | Alpha CT   | Alpha ST   |
|---|------------|------------|
| Harga per meter <INC. STANDARD CARRIER> | 280.000    | 595.000    |
| Harga per batang                        | 1.285.000  | 3.000.000  |
| Harga paket (20btg)                     | 22.850.000 | 45.600.000 |

### isi 1 batang komplit :

|                         |           |
|-------------------------|-----------|
| Curtain Rail            | 6 m       |
| Carrier / Roda          | 60 pcs    |
| End Cup Plastic         | 6 pcs     |
| Bracket Single / Double | 6 / 3 pcs |

### Harga komponen satuan

|                                  |              |
|----------------------------------|--------------|
| End Controller Set               | 94.000 /set  |
| End Cap ST Manual                | 10.800 /pcs  |
| End Cap CT Manual                | 3.800 /pcs   |
| Carrier Set                      | 6.150 /pcs   |
| Ripple Hook Single               | 2.550 /pcs   |
| Ripple Hook Double               | 3.800 /pcs   |
| Ripple Carrier                   | 5.050 /pcs   |
| Link Chain for Carrier ST 6/8 cm | 8.900 /m'    |
| Ripple Tape 12.5/14.5 cm         | 47.000 /m'   |
| Master Carrier Set (Stainless)   | 350.000 /set |
| Rippler Master Carrier           | 120.000 /set |
| Bracket Single Ceiling           | 19.000 /pcs  |
| Bracket Single Wall              | 44.000 /pcs  |
| Bracket Double Wall              | 66.000 /pcs  |
| Bracket Double Wall (Long)       | 83.500 /pcs  |

# Focus Track

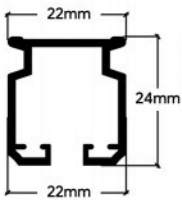

Harga per meter <INC. STANDARD CARRIER>  
 Harga per batang  
 Harga paket (20btg)

|   |            |
|---|------------|
| Harga per meter <INC. STANDARD CARRIER> | 270.000    |
| Harga per batang                        | 1.270.000  |
| Harga paket (20btg)                     | 22.000.000 |

### isi 1 batang komplit :

|                         |           |
|-------------------------|-----------|
| Curtain Rail            | 6 m       |
| Carrier / Roda          | 60 pcs    |
| End Cup Plastic         | 6 pcs     |
| Bracket Single / Double | 6 / 3 pcs |

### Harga komponen satuan

|                        |             |
|------------------------|-------------|
| Carrier                | 5.600 /pcs  |
| End Cap                | 7.500 /pcs  |
| Bracket Single Ceiling | 11.600 /pcs |
| Bracket Single Wall    | 20.600 /pcs |
| Master Carrier Set     | 57.500 /set |
| Controller Set         | 80.000 /set |

### HARGA SUDAH TERMASUK PPN

1. Minimum order Curtain Track adalah lebar 1m
2. Manual system tidak termasuk master carrier / overlap arm
3. Biaya pemasangan wilayah Jakarta Rp 11.000/m' (min 15m')

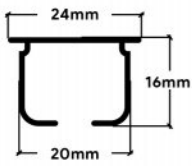

Manual



Stick



**15**  
kg

Max Load



Harga per meter <INC. STANDARD CARRIER>  
 Harga per batang  
 Harga paket (20btg)

EP Cream  
 Komponen Prima  
 ●  
 155.000  
 765.000  
 13.500.000

EP Cream  
 Komponen Econo  
 ●  
 112.500  
 610.000  
 10.500.000

| isi 1 batang komplet :  |           |
|-------------------------|-----------|
| Curtain Rail            | 6 m       |
| Carrier Standard / Roda | 60 pcs    |
| End Cup Plastic         | 6 pcs     |
| Bracket Single / Double | 6 / 3 pcs |

| Harga komponen satuan  |            |
|------------------------|------------|
| Carrier/ Roda          | 5.600/pcs  |
| End Cup Plastic        | 2.000/pcs  |
| Bracket Single Ceiling | 11.600/pcs |
| Bracket Single Wall    | 20.600/pcs |

# Econo Track

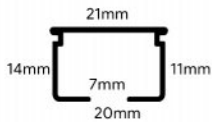

● Silver

● Brown

○ White

● Gold



Harga per meter <INC. STANDARD CARRIER>  
 Harga per batang  
 Harga paket (20btg)

54.000  
 280.000  
 5.040.000

| isi 1 batang komplet :  |           |
|-------------------------|-----------|
| Curtain Rail            | 6 m       |
| Carrier Standard / Roda | 60 pcs    |
| End Cup Plastic         | 6 pcs     |
| Bracket Single / Double | 6 / 3 pcs |

| Harga komponen satuan  |            |
|------------------------|------------|
| Carrier/ Roda          | 1.500/pcs  |
| End Cup Plastic        | 2.000/pcs  |
| Bracket Single Ceiling | 11.600/pcs |
| Bracket Single Wall    | 13.000/pcs |

## HARGA SUDAH TERMASUK PPN

1. Minimum order Curtain Track adalah lebar 1m
2. Manual system tidak termasuk master carrier / overlap arm
3. Biaya pemasangan wilayah Jakarta Rp 11.000/m' (min 15m')

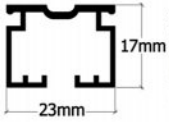

SP 81 CT



Pully Manual Wand



White / Brown



Harga per meter <INC. STANDARD CARRIER>

Harga per batang

Harga paket (20btg)

110.000

540.000

9.500.000

### 1 Batang <CT HEAD RAIL> + isi

|                         |           |
|-------------------------|-----------|
| Curtain Rail            | 6 m       |
| Carrier / Roda          | 60 pcs    |
| End Cup Plastic         | 6 pcs     |
| Bracket Single / Double | 6 / 3 pcs |

### Harga komponen satuan

|                               |             |
|-------------------------------|-------------|
| Carrier / Roda                | 2.550 /pcs  |
| End Cup Plastic               | 8.900 /pcs  |
| Bracket Single (Ceiling/Wall) | 13.000 /pcs |
| Bracket Double (Ceiling/Wall) | 31.000 /pcs |
| Controller + End Cup Set      | 47.000 /pcs |
| Master Carrier + Overlap Arm  | 45.500 /set |
| Nylon Cord HT 2.2mm           | 2.700 /m    |
| Tension Pully                 | 70.000 /pcs |
| Cord Weight                   | 28.000 /pcs |

# Silent Track

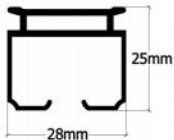

Silent Track Electro Painting HD



Manual Wand



\*dapat menggunakan master carrier H&H

Cream



Harga per meter <INC. STANDARD CARRIER>

Harga per batang

Harga paket (20btg)

270.000

1.300.000

22.000.000

### 1 Batang <CT HEAD RAIL> + isi

|                 |        |
|-----------------|--------|
| Curtain Rail    | 6 m    |
| Carrier / Roda  | 60 pcs |
| End Cup Plastic | 6 pcs  |
| Bracket Single  | 6 pcs  |

### Harga komponen satuan

|                               |             |
|-------------------------------|-------------|
| Carrier / Roda                | 7.600 /pcs  |
| End Cup Plastic               | 8.900 /pcs  |
| Bracket Single (Ceiling/Wall) | 13.000 /pcs |

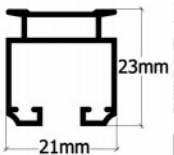

Silent Track Powder Coating



Manual Wand



White/Cream



Harga per meter <INC. STANDARD CARRIER>

Harga per batang

Harga paket (20btg)

215.000

995.000

18.000.000

### 1 Batang <CT HEAD RAIL> + isi

|                 |        |
|-----------------|--------|
| Curtain Rail    | 6 m    |
| Carrier / Roda  | 60 pcs |
| End Cup Plastic | 6 pcs  |
| Bracket Single  | 6 pcs  |

### Harga komponen satuan

|                               |             |
|-------------------------------|-------------|
| Carrier / Roda                | 5.700 /pcs  |
| End Cup Plastic               | 7.600 /pcs  |
| Bracket Single (Ceiling/Wall) | 13.000 /pcs |

### HARGA SUDAH TERMASUK PPN

1. Minimum order 81 Track & Silent Track adalah lebar 1m
2. Manual system tidak termasuk master carrier / overlap arm
3. Biaya pemasangan wilayah Jakarta Rp 11.000/m' (min 15m')

### Super Track CT

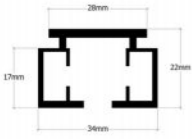

Manual Wand



### Super Track ST

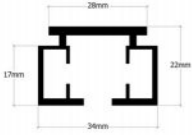

Manual Wand



### Super Track CT with Chain Operation

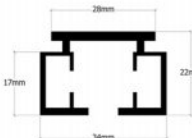

Chain



### Super Track ST with Chain Operation

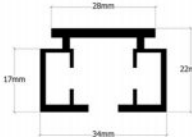

Chain



Lurus

Lengkung

CT Super Track Chain + Belt System  
 CT Super Track Manual  
 ST Super Track Chain + Belt System  
 ST Super Track Manual

Rp. 1.250.000/m<sup>1</sup>  
 Rp. 730.000/m<sup>1</sup>  
 Rp. 1.940.000/m<sup>1</sup>  
 Rp. 1.380.000/m<sup>1</sup>

Rp. 1.750.000/m<sup>1</sup>  
 Rp. 1.230.000/m<sup>1</sup>  
 Rp. 2.440.000/m<sup>1</sup>  
 Rp. 1.880.000/m<sup>1</sup>

#### HARGA SUDAH TERMASUK PPN

1. Minimum order Super Track adalah lebar 2.50 m (lebar kurang dari 2.50m)
2. Joint 90° / Lengkung 90° : Rp. 600.000/pcs
3. Biaya pasang wilayah Jakarta Rp. 11.000/m<sup>1</sup> (netto) minimal 15m

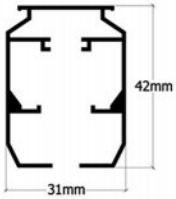

Aristocrat - with 36 CT HD track (Magic Pump)

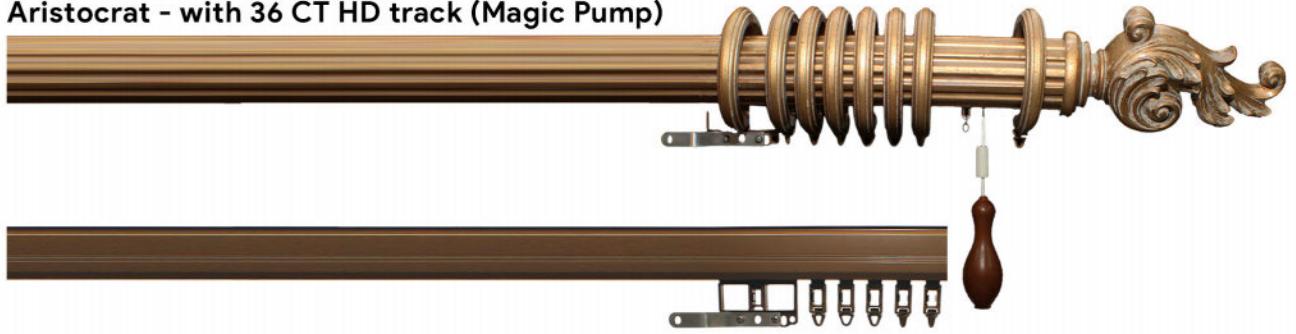

Lyon Finial - Glow



Greek Finial - Gold



Lyon Finial - Glow



Cambria Finial - Gold



Greek Finial - Bright Gold

Aristocrat

Single  
Rp. /m<sup>1</sup>  
2.350.000

Double  
Rp. /m<sup>1</sup>  
3.450.000

NOVO  
Motorized  
7.000.000/set

### HARGA SUDAH TERMASUK PPN 10%

1. Minimum lebar Sharp Point Aristocrat adalah L 2.6m (kelipatan lebar dihitung per 10cm end to end)
2. Penambahan runner + ring : Rp. 49.000/pcs
3. Single resin wall bracket : Rp. 692.000/pcs  
Double resin wall bracket : Rp. 1.380.000/pcs
4. Biaya pasang wilayah Jakarta : Rp. 11.000/m (netto) minimal 15m

## 36 Track

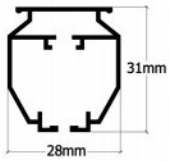

SP 36 ST - with Magic Pump



SP 36 CT - with Magic Pump



36 Track CT  
36 Track ST

Satin White  
Standard  
Rp. /m<sup>1</sup>  
550.000  
625.000

Heavy Duty  
White/Brown  
Rp. /m<sup>1</sup>  
890.000  
-

### HARGA SUDAH TERMASUK PPN

1. Minimum lebar Sharp Point 36 Track adalah 1.6m (kelipatan lebar dihitung per 10cm end to end)
2. Penambahan runner CT : Rp. 3.900/pcs
3. Biaya pasang wilayah Jakarta : Rp. 11.000/m (netto) minimal 15m

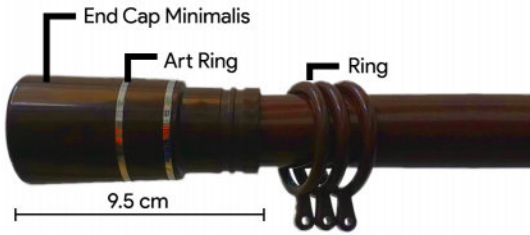

Diameter 3.0cm  
Aluminium 1.2mm - Brown

Diameter 3.0cm  
Aluminium 1.2mm - White

Diameter 3.0cm  
Aluminium 1.2mm - Black



|                          |     |              |
|--------------------------|-----|--------------|
| Head rail polos (kosong) | Rp. | 600.000 /btg |
| Endcap                   | Rp. | 40.000 /pcs  |
| Bracket                  | Rp. | 47.500 /pcs  |
| Ring                     | Rp. | 1.000 /pcs   |

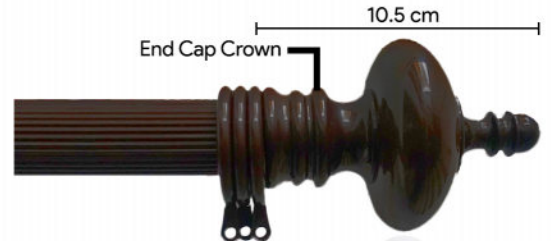

|                          |     |              |
|--------------------------|-----|--------------|
| Head rail garis (kosong) | Rp. | 475.000 /btg |
| Endcap                   | Rp. | 40.000 /pcs  |
| Bracket                  | Rp. | 47.500 /pcs  |
| Ring                     | Rp. | 1.000 /pcs   |



Diameter 3.0cm  
Aluminium 1.2mm - Silver

Diameter 3.0cm  
Aluminium 1.2mm - Gold



|                          |     |              |
|--------------------------|-----|--------------|
| Head rail polos (kosong) | Rp. | 700.000 /btg |
| Endcap                   | Rp. | 62.500 /pcs  |
| Bracket                  | Rp. | 47.500 /pcs  |
| Ring                     | Rp. | 5.500 /pcs   |



|                          |     |              |
|--------------------------|-----|--------------|
| Head rail garis (kosong) | Rp. | 565.000 /btg |
| Endcap                   | Rp. | 62.500 /pcs  |
| Bracket                  | Rp. | 47.500 /pcs  |
| Ring                     | Rp. | 5.500 /pcs   |

**Bracket Single Tersedia 5 Warna**



**Ring Tersedia 5 Warna**



**HARGA SUDAH TERMASUK PPN**

1. Endcap minimalis brown, white, black; pilihan art ring : silver / gold
2. Endcap minimalis gold, silver; pilihan art ring : black / gold
3. Biaya pasang wilayah Jakarta : Rp. 11.000/m (netto) minimal 15m

### RTS Motor

|                            |                     |
|----------------------------|---------------------|
| SOMFY Glydea Ultra 35e RTS | Rp. 11.000.000 /pcs |
| SOMFY Glydea Ultra 60e RTS | Rp. 16.800.000 /pcs |
| SOMFY Movelite 35 RTS      | Rp. 8.600.000 /pcs  |
| SHARP POINT NC-50-N2       | Rp. 2.450.000 /pcs  |
| NOVO N 17                  | Rp. 3.000.000 /pcs  |
| NOVO N 21 - 4A5            | Rp. 2.600.000 /pcs  |

### Wired Motor

|                      |                     |
|----------------------|---------------------|
| SOMFY Glydea 60e WT  | Rp. 15.100.000 /pcs |
| SOMFY Glydea 35e WT  | Rp. 9.100.000 /pcs  |
| SOMFY Movelite 35 WT | Rp. 7.200.000 /pcs  |
| NOVO N 21 WT         | Rp. 2.100.000 /pcs  |

### Smart Motor with TUYA Protocol

|                                  |                    |
|----------------------------------|--------------------|
| NOVO N21 Tuya RTS 3E             | Rp. 2.950.000 /pcs |
| NOVO C105 Adjustable* 167-300 cm | Rp. 3.750.000 /pcs |
| NOVO C105 Adjustable* 242-450 cm | Rp. 4.250.000 /pcs |

\*NOVO C105 Adjustable include : Motor, Rail, Remote & Aksesoris

### Controller

|                              |                    |
|------------------------------|--------------------|
| SOMFY Remote Situo RTS 1 Ch  | Rp. 985.000 /pcs   |
| SOMFY Remote Situo 1 Ch      | Rp. 1.345.000 /pcs |
| SOMFY Remote Situo 2 Ch      | Rp. 1.995.000 /pcs |
| SOMFY Remote Situo 5 Ch      | Rp. 2.400.000 /pcs |
| SOMFY Telis 16 RTS Pure Intl | Rp. 8.300.000 /pcs |
| Dry Contact Transmitter      | Rp. 8.350.000 /pcs |
| Sharp Point Remote 1-5 Ch    | Rp. 720.000 /pcs   |
| Novo Receiver                | Rp. 660.000 /pcs   |
| Novo Remote 1-5 Ch           | Rp. 660.000 /pcs   |

### System Components

Harga sudah termasuk : textile belt, runner, master carrier L/R, ceiling bracket, drive pulley set L/R (minimum order L 2.60m)

|                                     |                                  |
|-------------------------------------|----------------------------------|
| Curtain Track Glydea (Silent)       | Rp. 2.160.000 /m*                |
| Curtain Track Glydea (Regular)      | Rp. 980.000 /m*                  |
| Curtain Track Sharp Point (Regular) | Rp. 900.000 /m*                  |
| Curtain Track NOVO (Regular)        | Rp. 900.000 /m*                  |
| Curved Track                        | Regular Track + 60%              |
| Upgrade S Track                     | Standard Runner + Rp. 950.000/m* |

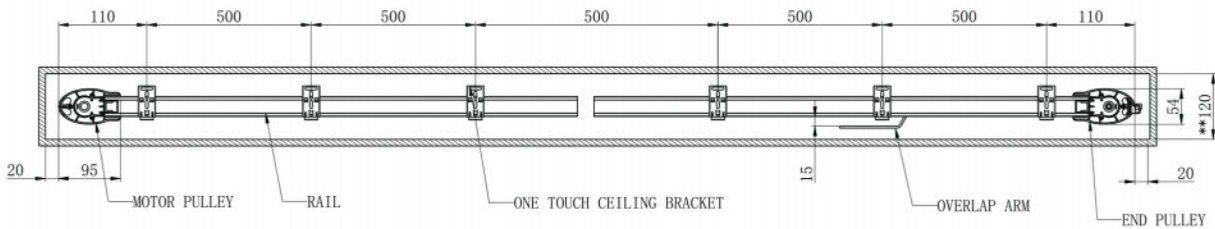

# Stage Curtain Heavy Duty

## 5 Years Component Guarantee\*

- Oriental Curtain Heavy Duty
- Rel Extreme Heavy Duty
- SOMFY Receiver Centralis

|                     |
|---------------------|
| Rp. 23.500.000 /pcs |
| Rp. 2.250.000 /pcs  |
| Rp. 6.200.000 /pcs  |



Oriental Curtain Track mampu mengangkat beban kain hingga 120kg



### HARGA SUDAH TERMASUK PPN

- Biaya pasang Curtain Track Motorized Sharp Point : Rp. 250.000/set





1.40 m  $\leftrightarrow$   
Rp. 155.000



2.80 m  $\leftrightarrow$   
Rp. 555.000



2.80 m  $\leftrightarrow$   
Rp. 310.000



3.00 m  $\leftrightarrow$   
V1 Rp. 150.000  
V2 Rp. 185.000  
V3 Rp. 215.000



3.00 m  $\leftrightarrow$   
Rp. 620.000



1.40 m  $\leftrightarrow$   
Rp. 510.000



3.00 m  $\leftrightarrow$   
Rp. 600.000



1.40 m  $\leftrightarrow$   
LISA Rp. 556.000  
LINDRA Rp. 556.000  
LIZZO Rp. 620.000  
ALDO Rp. 645.000



3.00 m  $\leftrightarrow$   
SH 1 Rp. 209.000  
SH 2 Rp. 198.000  
SH 3 Rp. 258.000  
SH 4 Rp. 188.000



3.00 m  $\leftrightarrow$   
1-15 Rp. 460.000  
16-24 Rp. 510.000  
25-36 Rp. 570.000

## Sharp Point Hospital Fabric

Rp. 194.000/m<sup>1</sup>

$\leftrightarrow$  1.50 m  
PVC Silver Backing

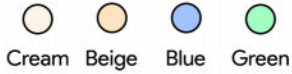

Rp. 168.000/m<sup>1</sup>

$\leftrightarrow$  2.00 m  
PVC Standard

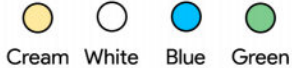

$\updownarrow$  2.80 m  
HF 01 - AB - FR

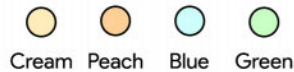

Rp. 437.000/m<sup>1</sup>

$\updownarrow$  2.80 m  
HF 01 - AB - Non FR

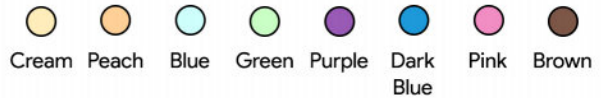

Rp. 335.000/m<sup>1</sup>

$\updownarrow$  2.80 m  
HF 02 - AB - Non FR

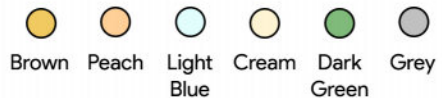

Rp. 292.000/m<sup>1</sup>

## HARGA SUDAH TERMASUK PPN

1. Minimum order Lebar dan Tinggi kurang dari 1m dibulatkan menjadi 1m (lebar dan tinggi kurang dari 1m dihitung 1m)
2. Biaya pemasangan daerah Jakarta = Rp. 11.000/m<sup>2</sup> netto (minimal 15m<sup>2</sup>)
3. Biaya jahit **rempel / triple pinch pleat** Rp. 12.500/m1 netto  
**eyelet/ mata ayam** Rp. 20.000/m1 netto



### Aluminium Stick



Stick Diameter : 9mm

|        |                  |
|--------|------------------|
| 100 cm | Rp. 204.000 /pcs |
| 120 cm | Rp. 242.000 /pcs |
| 150 cm | Rp. 267.000 /pcs |
| 300 cm | Rp. 483.000 /pcs |

### 18 cm Universal Bracket

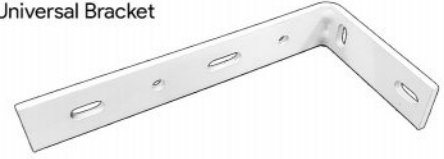

|       |                  |
|-------|------------------|
| 18 cm | Rp. 138.000 /pcs |
|-------|------------------|

### Stainless Steel Stick



Stick Diameter : 12mm

|        |                  |
|--------|------------------|
| 100 cm | Rp. 366.000 /pcs |
| 120 cm | Rp. 407.000 /pcs |
| 150 cm | Rp. 458.000 /pcs |

### 11 cm Universal Bracket

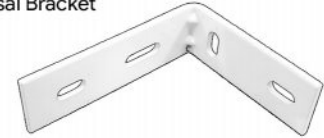

|       |                 |
|-------|-----------------|
| 11 cm | Rp. 89.000 /pcs |
|-------|-----------------|



7.2 mm  
Chain Safety Device

Rp. 39.000



6.0 mm  
Chain Safety Device

Rp. 37.000



Cord  
Weight

Rp. 28.000

### Tension Pully

Posisi Pasang  
di Tembok



Posisi Pasang  
di Lantai



Rp. 70.000/pcs

| Lebar<br>(Kesamping) | Panjang (Kedepan) |            |            |            |            |            |
|----------------------|-------------------|------------|------------|------------|------------|------------|
|                      | 1.50              | 2.00       | 2.50       | 3.00       | 3.50       | 4.00       |
| 1.55 - 2.00 m        | 15.937.000        |            |            |            |            |            |
| 2.10 - 3.00 m        | 17.500.000        | 18.312.000 | 19.412.000 |            |            |            |
| 3.10 - 4.00 m        | 19.125.000        | 20.450.000 | 22.500.000 | 24.281.000 | 28.125.000 |            |
| 4.10 - 5.00 m        | 22.425.000        | 25.425.000 | 27.887.000 | 29.125.000 | 32.250.000 | 41.500.000 |
| 5.10 - 6.00 m        | 28.350.000        | 30.250.000 | 32.250.000 | 33.625.000 | 35.625.000 | 45.000.000 |
| 6.10 - 7.00 m        | 33.375.000        | 35.875.000 | 39.625.000 | 41.500.000 | 47.500.000 | 52.125.000 |
| 7.10 - 8.00 m        | 41.250.000        | 43.125.000 | 48.000.000 | 52.000.000 | 58.500.000 | 62.250.000 |
| 8.10 - 9.00 m        | 45.000.000        | 48.125.000 | 51.250.000 | 55.125.000 | 61.250.000 | 64.812.000 |
| 9.10 - 10.00 m       | 49.000.000        | 51.875.000 | 55.250.000 | 60.000.000 | 63.750.000 | 67.000.000 |
| 10.10 - 11.00 m      | 50.375.000        | 53.750.000 | 57.875.000 | 63.000.000 | 70.000.000 | 75.125.000 |



MOTOR - SOMFY Solus 2 PA 40/12  
 RECEIVER - Somfy Universal Receiver Inteo  
 REMOTE - Somfy Situo 1 RTS Pure  
 COMPONENT - crown + wheel + idler + kabel power 2m + steker

Rp. 13.395.000/set

MOTOR - SOMFY Solus 2 PA 40/12  
 RECEIVER - Sharp Point Receiver  
 REMOTE - Sharp Point Remote 1-5 Ch  
 COMPONENT - crown + wheel + idler + kabel power 2m + steker

Rp. 7.970.000/set

MOTOR - SOMFY Altus 60 RTS 85/17  
 REMOTE - Somfy Situo 1 RTS Pure  
 COMPONENT - crown + wheel + idler + kabel power 2m + steker

Rp. 20.545.000/set

MOTOR - DOOYA DM-45-M 50/12 (manual override)  
 RECEIVER - Dooya Receiver  
 REMOTE - Dooya Remote  
 COMPONENT - crown + wheel + idler + kabel power 2m + steker

Rp. 4.950.000/set

MOTOR - NOVO K-45-EL 50/12  
 RECEIVER - NOVO Receiver  
 REMOTE - NOVO Remote  
 COMPONENT - crown + wheel + idler + kabel power 2m + steker

Rp. 4.140.000/set

|                          |                       |
|--------------------------|-----------------------|
| Bracket Ceiling Big      | Rp. 1.450.000 /pcs    |
| Bracket Ceiling Small    | Rp. 1.350.000 /pcs    |
| Central Supporting Wheel | Rp. 980.000 /pcs      |
| 1.5 m Arm                | Rp. 4.350.000 /pasang |
| 2.0 m Arm                | Rp. 4.620.000 /pasang |
| 2.5 m Arm                | Rp. 5.450.000 /pasang |
| 3.0 m Arm                | Rp. 6.025.000 /pasang |
| 3.5 m Arm                | Rp. 8.000.000 /pasang |
| 4.0 m Arm                | Rp. 8.600.000 /pasang |

### HARGA SUDAH TERMASUK PPN

1. Pemesanan minimum lebar 2.00m x 1.50m
2. Biaya pemasangan daerah Jakarta = Rp. 35.000/m<sup>2</sup> (minimal 10m<sup>2</sup>)

| LEBAR<br>(SAMPING) | PANJANG (DEPAN) |            |            |
|--------------------|-----------------|------------|------------|
|                    | 1,00 m          | 1,20 m     | 1,40 m     |
| 1,80 m             | 7.582.000       |            |            |
| 2,10 m             | 8.636.000       |            |            |
| 2,40 m             | 9.652.000       | 10.846.000 |            |
| 2,70 m             | 10.618.000      | 11.938.000 | 13.259.000 |
| 3,00 m             | 11.545.000      | 12.980.000 | 14.402.000 |
| 3,30 m             | 12.421.000      | 13.970.000 | 15.494.000 |
| 3,60 m             | 13.272.000      | 14.923.000 | 16.574.000 |
| 3,90 m             | 14.085.000      | 15.837.000 | 17.590.000 |
| 4,20 m             | 14.872.000      | 15.914.000 | 18.555.000 |
| 4,50 m             | 15.774.000      | 17.717.000 | 19.673.000 |
| 4,80 m             | 16.637.000      | 18.708.000 | 20.752.000 |
| 5,10 m             | 17.501.000      | 19.533.000 | 21.362.000 |
| 5,40 m             | 18.377.000      | 20.549.000 | 22.937.000 |
| 5,70 m             | 19.025.000      | 21.362.000 | 23.711.000 |
| 6,00 m             | 19.660.000      | 22.098.000 | 24.524.000 |

Kanopi  
1. Lipat  
Lengkung

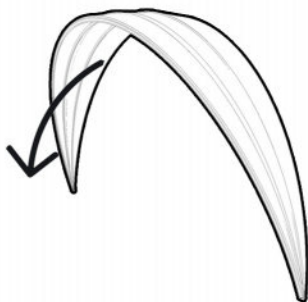

Posisi Tertutup

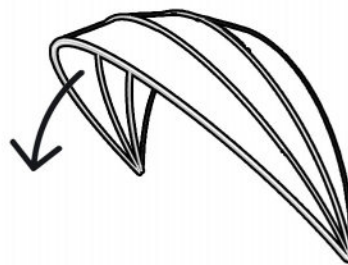

Posisi 1/2 Terbuka

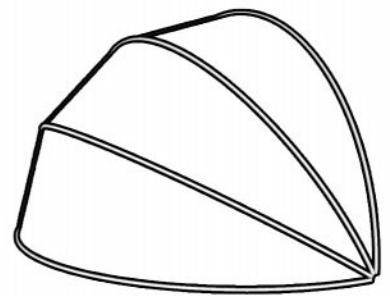

Posisi Terbuka

Kanopi  
2. Lipat  
Standart

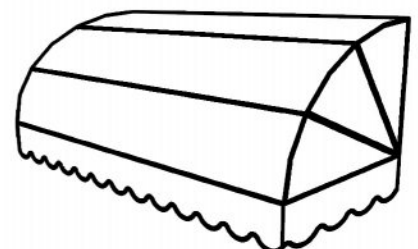
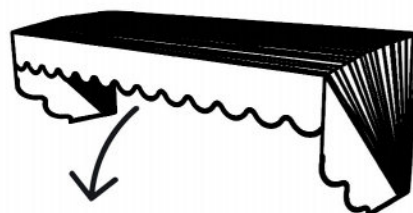
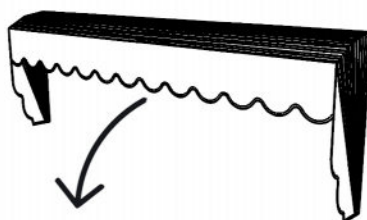

**HARGA SUDAH TERMASUK PPN**

1. Bahan : Dickson - Acrylic | Mehler - Tivoli (Garansi 5 Tahun)
2. Biaya pemasangan daerah Jakarta = Rp. 35.000/m<sup>2</sup> netto (minimal 6m<sup>2</sup>)

**Dasar Perhitungan Volume**  
minimal order 6.00 m<sup>2</sup>

**Aluminium**  
hollow 1" x 1.2mm

**Alu Knock-down**  
hollow 1" x 1.2mm

**Besi**  
hollow 2x4 / 4x4  
sambung las  
finishing cat

| No. | Diagram | Dasar Perhitungan Volume               | Aluminium     | Alu Knock-down | Besi          |
|-----|---------|--|---------------|----------------|---------------|
| 1.  |         | $(L \times B) + (A \times B \times 2)$ | Rp. 2.223.000 | Rp. 3.556.000  | Rp. 2.350.000 |
| 2.  |         | $(L \times B) + (A \times B \times 2)$ | Rp. 2.223.000 | Rp. 3.556.000  | Rp. 2.350.000 |
| 3.  |         | $(L \times B) + (A \times B \times 2)$ | Rp. 2.223.000 | Rp. 3.556.000  | Rp. 2.350.000 |
| 4.  |         | $(L \times B) + (A \times B \times 2)$ | Rp. 2.223.000 | Rp. 3.556.000  | Rp. 2.350.000 |
| 5.  |         | $(1 + 2) \times L$                     | Rp. 2.845.000 | Rp. 4.547.000  | Rp. 3.023.000 |
| 6.  |         | $(1 + 2) \times L$                     | Rp. 2.845.000 | Rp. 4.547.000  | Rp. 3.023.000 |

**HARGA SUDAH TERMASUK PPN**

- 1. Bahan : Dickson - Acrylic | Mehler - Tivoli (Garansi 5 Tahun)
- 2. Biaya pemasangan daerah Jakarta = Rp. 35.000/m<sup>2</sup> netto (minimal 6m<sup>2</sup>)



# 2022 PRICE LIST

# Tension Membrane

5 Years Component Guarantee\*

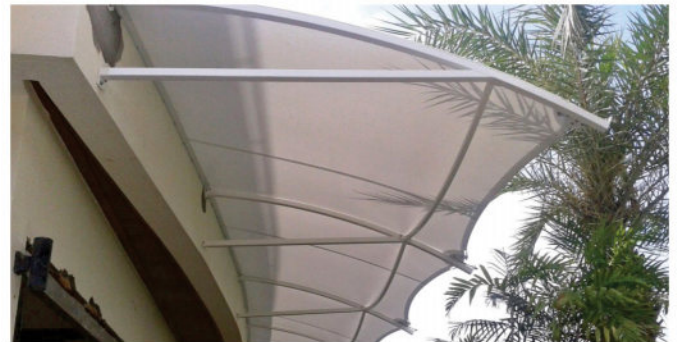

### Pilihan Bahan

Serge Ferrari 702 S2  
AGTex 751  
AGTex 951

### Harga (Rp/m<sup>2</sup>)

Rp. 3.600.000 /m<sup>2</sup>  
Rp. 3.250.000 /m<sup>2</sup>  
Rp. 3.660.000 /m<sup>2</sup>

### Standar diameter pipa struktur

Pipa untuk lebar : 2.5' - 3.0'  
Pipa untuk panjang : 2.5' - 4.0'  
(menyesuaikan kebutuhan panjang & lokasi)

Jarak pipa per lebar 1.50m - 3.00m

Penghitungan dengan metode end to end (pipa terluar)

Pondasi / Cakar ayam : Rp. 3.500.000/m<sup>3</sup> (netto)



### HARGA SUDAH TERMASUK PPN

1. Lebar maksimum ke samping tidak terhingga (selama ada dukungan struktur)
2. Panjang maksimum ke depan : 7.00 m
3. Minimum order lebar 1m dan panjang 1m dengan minimum charge 12m<sup>2</sup>



# 2022 PRICE LIST

# Tension Membrane

5 Years Component Guarantee\*



### Harga penambahan tiang

|     |                           |
|-----|---------------------------|
| 4"  | 937.500 /m <sup>1</sup>   |
| 6"  | 1.950.000 /m <sup>1</sup> |
| 8"  | 2.200.000 /m <sup>1</sup> |
| 10" | 4.440.000 /m <sup>1</sup> |
| 12" | 5.450.000 /m <sup>1</sup> |

### Harga span screw

|       |                |
|-------|----------------|
| 12 mm | 750.000 /pcs   |
| 16 mm | 1.520.000 /pcs |



### Harga penambahan sling stainless steel

|       |                         |
|-------|-------------------------|
| 6 mm  | 130.000 /m <sup>1</sup> |
| 8 mm  | 230.000 /m <sup>1</sup> |
| 10 mm | 320.000 /m <sup>1</sup> |
| 12 mm | 490.000 /m <sup>1</sup> |

### Harga penambahan sling baja / galvanis

|       |                         |
|-------|-------------------------|
| 6 mm  | 56.000 /m <sup>1</sup>  |
| 8 mm  | 66.000 /m <sup>1</sup>  |
| 10 mm | 84.000 /m <sup>1</sup>  |
| 12 mm | 118.000 /m <sup>1</sup> |

### HARGA SUDAH TERMASUK PPN

1. Lebar maksimum ke samping tidak terhingga (selama ada dukungan struktur)
2. Panjang maksimum ke depan : 7.00 m
3. Minimum order lebar 1m dan panjang 1m dengan minimum charge 12m<sup>2</sup>



**Fabric yang dapat digunakan :** Serge Ferrari S86, S92, B92, S88 Alu LowE, S96, W96, 702S2, AGTex 751, AGTex 951

### HARGA SUDAH TERMASUK PPN

1. Lebar maksimum ke samping tidak terhingga (selama ada dudukan struktur)
2. Panjang maksimum ke depan : 7.00 m
3. Minimum order lebar 1m dan panjang 1m dengan minimum charge 12m<sup>2</sup>





**Fabric yang dapat digunakan :** Serge Ferrari S86, S92, B92, S88 Alu LowE, S96, W96, 702S2, AGTex 751, AGTex 951

### HARGA SUDAH TERMASUK PPN

1. Lebar maksimum ke samping tidak terhingga (selama ada dudukan struktur)
2. Panjang maksimum ke depan : 7.00 m
3. Minimum order lebar 1m dan panjang 1m dengan minimum charge 12m<sup>2</sup>



## Shutter Alumunium

Rp. 6.800.000/m<sup>2</sup>  
Ukuran slat = 9 mm x 635 mm  
Harga termasuk kusen  
Belum termasuk kunci  
Max lebar 1.20 m  
Max tinggi 2.80 m

Minimum order  
L & T kurang dari 1m dihitung 1m  
L 0.60 x T 2.00 = 2 m<sup>2</sup>



## Shutter Kayu

Rp. 6.600.000/m<sup>2</sup>  
Ukuran slat = 9 mm x 65 mm  
Harga termasuk kusen standar 28 mm x 55 mm  
Belum termasuk kunci  
Max lebar 1.20 m  
Max tinggi 2.80 m

Minimum order  
L & T kurang dari 1m dihitung 1m  
L 0.60 x T 2.00 = 2 m<sup>2</sup>

### HARGA SUDAH TERMASUK PPN

1. Minimum order Shutter adalah 1.00m<sup>2</sup> (lebar dan tinggi kurang dari 1.00m tetap dihitung 1.00m<sup>2</sup>)
2. Biaya pasang : Rp. 250.000/pintu (netto)



### Steel Security Door

Rp. 8.250.000 /pintu  
Ukuran standar 90 x 210 /pintu  
(MINIMUM ORDER/SET)

Max lebar 108 cm  
Max tinggi 258 cm

Diluar ukuran standar berlaku perhitungan  
harga volume Rp. 4.400.000/m<sup>2</sup>



### Teralis Expanda

Max lebar 106 cm  
Max tinggi 260 cm

Rp. 2.300.000/m<sup>2</sup>  
**include** kasa nyamuk parabola  
(MINIMUM ORDER 0.5M<sup>2</sup>)

Rp. 1.980.000/m<sup>2</sup>  
**tanpa kasa** nyamuk parabola  
(MINIMUM ORDER 0.5M<sup>2</sup>)

### Pintu Expanda + Kasa

Rp. 6.600.000 /pintu  
Ukuran standar 90 x 210 /pintu  
(MINIMUM ORDER/SET)

Max lebar 106 cm  
Max tinggi 260 cm

Diluar ukuran standar berlaku perhitungan  
harga volume Rp. 3.500.000/m<sup>2</sup>

### Ilustrasi Perhitungan

$$L 0.95 \times T 2.50 = 2.37 \text{ m}^2 \times 4.400.000$$

$$L 0.95 \times T 2.00 = 0.05 \times 2.10 = (0.10 \times 4.400.000) + 8.250.000$$

$$L 0.75 \times T 2.50 = 0.90 \times 0.40 = (0.36 \times 4.400.000) + 8.250.000$$

### HARGA SUDAH TERMASUK PPN

1. Semua pintu sudah termasuk kunci standar & engsel
2. Biaya pasang : Rp. 250.000/pintu (netto)
3. Biaya pasang teralis : Rp. 150.000/m<sup>2</sup> (netto)

### Pintu Expanda

Rp. 5.550.000 /pintu  
Ukuran standar 90 x 210 /pintu  
(MINIMUM ORDER/SET)

Max lebar 106 cm  
Max tinggi 260 cm

Diluar ukuran standar berlaku perhitungan  
harga volume Rp. 2.900.000/m<sup>2</sup>

|                                  | List & Kusen PVC<br>Luar Kusen       |                              | List & Kusen PVC<br>Dalam Kusen      |                              | List PVC, Kusen Alu<br>Dalam Kusen   |                              | List Alu, Kusen Alu<br>Luar Kusen    |                              | List Alu, Kusen Alu<br>Dalam Kusen   |                              |
|----------------------------------|--------------------------------------|------------------------------|--------------------------------------|------------------------------|--------------------------------------|------------------------------|--------------------------------------|------------------------------|--------------------------------------|------------------------------|
|                                  | /m <sup>2</sup><br>Rp/m <sup>2</sup> | <0.5m <sup>2</sup><br>Rp/Set | /m <sup>2</sup><br>Rp/m <sup>2</sup> | <0.5m <sup>2</sup><br>Rp/Set | /m <sup>2</sup><br>Rp/m <sup>2</sup> | <0.5m <sup>2</sup><br>Rp/Set | /m <sup>2</sup><br>Rp/m <sup>2</sup> | <0.5m <sup>2</sup><br>Rp/Set | /m <sup>2</sup><br>Rp/m <sup>2</sup> | <0.5m <sup>2</sup><br>Rp/Set |
| <b>Magnetic Insect Screen</b>    |                                      |                              |                                      |                              |                                      |                              |                                      |                              |                                      |                              |
| Fiber                            | 429.000                              | 246.000                      | 650.000                              | 445.000                      | 743.000                              | 539.000                      | 653.000                              | 473.000                      | 875.000                              | 670.000                      |
| Parabola Silver / Coating        | 690.000                              | 445.000                      | 967.000                              | 626.000                      | 1.060.000                            | 718.000                      | 915.000                              | 670.000                      | 1.192.000                            | 849.000                      |
| Miniflex / Semi Miniflex Coating | 808.000                              | 517.000                      | 1.066.000                            | 737.000                      | 1.157.000                            | 833.000                      | 1.044.000                            | 750.000                      | 1.290.000                            | 963.000                      |
| Parabola Stainless               | 953.000                              | 637.000                      | 1.127.000                            | 795.000                      | 1.221.000                            | 891.000                      | 1.209.000                            | 898.000                      | 1.355.000                            | 1.021.000                    |

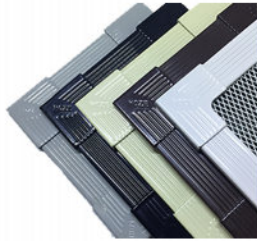

Screen Port Sliding / Swing : Rp. 120.000/pcs  
Color : Brown, White, Grey

Biaya 1/2 lingkaran : Rp. 250.000/set

## Folding Door & Folding Screen

### Folding Screen & Komponen

- Folding Screen Pintu
- Folding Screen Jendela
- PVC Folding Door T 2.20
- PVC Folding Door T 3.00
- Kunci "Sea-bird"
- Kunci "Sea-eagle"
- Kunci PVC (tanpa anak kunci)

|                              | 1 Arah (Rp.)              | Buka Tengah (Rp.)         |
|------------------------------|---------------------------|---------------------------|
| Folding Screen Pintu         | 2.852.000 /m <sup>2</sup> | 2.852.000 /m <sup>2</sup> |
| Folding Screen Jendela       | 1.653.000 /m <sup>2</sup> | 2.063.000 /m <sup>2</sup> |
| PVC Folding Door             | 2.380.000 /m <sup>1</sup> | 2.652.000 /m <sup>1</sup> |
| Kunci "Sea-bird"             |                           | 527.000 /pcs              |
| Kunci "Sea-eagle"            |                           | 357.000 /pcs              |
| Kunci PVC (tanpa anak kunci) |                           | 102.000 /pcs              |

\*folding screen pintu dan jendela tersedia dalam 2 warna frame (putih, coklat) dan 2 warna kasa (abu, hitam)

PVC Folding Door



Folding Screen Jendela



Folding Screen Pintu



Kunci Seabird



Kunci PVC



### HARGA SUDAH TERMASUK PPN

- Minimal order FS pintu
- Minimal order FS jendela
- Minimal order Folding door PVC
- Ongkos pasang FS pintu
- Ongkos pasang Folding door PVC
- Ongkos pasang FS jendela
- Ongkos pasang Insect Screen

Lebar & Tinggi < dari 1m dihitung 1m (minimal order 1m<sup>2</sup>)  
Hasil perkalian L x T < dari 1m<sup>2</sup> dihitung 1m<sup>2</sup>

Lebar minimal 1m<sup>1</sup>  
Rp. 150.000/set s/d Rp. 300.000/set minimal 1 set (netto)  
Rp. 150.000/m<sup>1</sup> (netto)  
Rp. 30.000 /set (tergantung lokasi; minimum Rp. 150.000/lokasi)  
Rp. 20.000 /set (tergantung lokasi; minimum Rp. 200.000/lokasi)

e.g : L 60 cm x T 200 cm = 2.0 m<sup>2</sup>  
e.g : L 60 cm x T 200 cm = 1.2 m<sup>2</sup>  
e.g : L 60 cm x T 1.20 cm = 1.0 m<sup>2</sup>

| Vinyl Flooring           | Ukuran<br>TxLxP (mm) | Qty (pcs)<br>/box | Weight (kg)<br>/box | Volume/box          | Harga/box |
|--------------------------|----------------------|-------------------|---------------------|---------------------|-----------|
| Vinyl Flooring 2mm       | 2 x 150 x 900        | 36                | 20.2                | 5.02 m <sup>2</sup> | 1.707.000 |
| Vinyl Flooring 3mm       | 3 x 150 x 900        | 24                | 20.2                | 3.34 m <sup>2</sup> | 1.477.000 |
| Vinyl Flooring 4mm       | 4 x 150 x 900        | 18                | 20.6                | 2.51 m <sup>2</sup> | 1.921.000 |
| Laminate Flooring 8.5 mm | 8 x 193 x 1215       | 8                 | 18.5                | 1.88 m <sup>2</sup> | 1.017.000 |
| Laminate Flooring 8.0 mm | 8 x 191 x 1205       | 8                 | 14.0                | 1.84 m <sup>2</sup> | 1.264.000 |
| Laminate Flooring 12 mm  | 12 x 161 x 1205      | 5                 | 11.0                | 0.97 m <sup>2</sup> | 1.056.000 |

| Supporting Component    | Ukuran<br>L x T (mm) | Panjang<br>(m) | Type   | Harga   |
|-------------------------|----------------------|----------------|--------|---------|
| End Profil - Alumunium  | 25 x 4               | 3              | V4mm   | 263.000 |
| Stair Noise - Alumunium | 25 x 25              | 3              | V4mm   | 379.000 |
| Transition - Alumunium  | 35 x 4               | 3              | V4mm   | 332.000 |
| PVC Skirting 75 mm      | 75 x 15.5            | 2.4            | EL8mm  | 345.000 |
| PVC F- Stairnoise 8 mm  | 34 x 25              | 2.7            | EL8mm  | 251.000 |
| PVC Reduce 8 mm         | 40 x 12              | 2.7            | EL8mm  | 251.000 |
| PVC T Cover 8 mm        | 40 x 11              | 2.7            | EL8mm  | 251.000 |
| PVC Endcap 8 mm         | 30 x 12              | 2.7            | EL8mm  | 251.000 |
| PVC Skirting 100 mm     | 100 x 15.5           | 2.4            | SO12mm | 389.000 |
| PVC F- Stairnoise 12 mm | 34 x 30              | 2.7            | SO12mm | 283.000 |
| PVC Reduce 12 mm        | 40 x 16              | 2.7            | SO12mm | 283.000 |
| PVC T Cover 12 mm       | 40 x 15              | 2.7            | SO12mm | 283.000 |
| PVC Endcap 12 mm        | 30 x 16              | 2.7            | SO12mm | 283.000 |

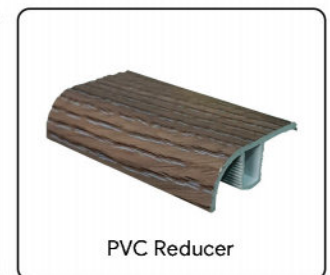
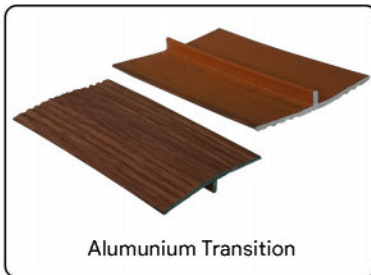

### HARGA SUDAH TERMASUK PPN

1. Minimum order Vinyl / Laminate flooring 1 box
2. Biaya pasang vinyl Rp. 35.000/m<sup>2</sup> (netto)



SHARP POINT IS USING PRODUCT(S) FROM :

